



NIEUWKOOP

USER MANUAL



EC3001

EC-TRANSMITTER

4-20mA – RS485



TO MEASURE  TO KNOW



Conductivity scales	: 2 μ S \div 2000 mS
TDS scales	: 1 ppm \div 1000 ppt
Temperature scales	: -10.0 \div 110.0 $^{\circ}$ C 14.0 \div 230.0 $^{\circ}$ F
Power supply	: 9 \div 36 Vdc
Installed firmware	: R 3.0x

Cod. 280063360

Rev. B

INDEX

1	GENERAL WARNINGS AND INFORMATION FOR ALL USERS	3
1.1	WARRANTY	3
1.2	AFTER SALES SERVICE	3
1.3	CE MARKING.....	3
1.4	SAFETY WARNINGS.....	3
1.5	MANUAL REVISIONS.....	4
2	PRODUCT OVERVIEW	5
2.1	FUNCTIONAL PURPOSE OF THE DEVICE.....	5
2.2	ACCESSORIES	5
3	INSTRUCTION MANUAL CONTENTS	6
3.1	SYMBOLS	6
3.2	HOW TO READ THE INSTRUCTION MANUAL	6
3.2.1	Using the instrument on the plant.....	7
3.2.2	Plant maintenance staff	7
3.2.3	Instrument installation.....	8
4	SPECIFICATIONS AND TECHNICAL DATA.....	9
4.1	FUNCTIONAL SPECIFICATION.....	9
4.2	TECHNICAL DATA.....	12
4.2.1	General specifications.....	12
4.2.2	Technical specifications.....	13
5	INSTALLATION.....	18
5.1	PACKING LIST.....	18
5.2	PACKING AND UNPACKING	18
5.3	STORAGE AND TRANSPORT	18
5.4	INSTALLATION OF THE TRANSMITTER.....	18
5.5	INSTALLATION OF THE SENSOR.....	18
5.6	ELECTRICAL INSTALLATION	19
5.6.1	Connection of the measuring cell.....	19
5.6.2	Connection of the temperature sensor	20
5.6.3	Connection of the current loop.....	20
5.6.4	Connection of the logic input.....	20
5.6.5	Connection to the RS485 serial port.....	21
5.6.6	Network connection (RS485).....	21
5.7	DISPOSAL.....	21



6	OPERATING PROCEDURE	22
6.1	OPERATING PRINCIPLES	22
6.2	DISPLAY	23
6.3	KEYS	23
6.4	INSTRUCTION FOR THE USER.....	24
6.4.1	TDS measuring.....	24
6.4.2	Conductivity measuring.....	24
6.4.3	Temperature measuring.....	24
6.4.4	Parameters reserved to the plant maintainer.....	25
6.4.5	Parameters reserved tot the plant engineer.....	25
6.4.6	Information display	25
6.5	MAINTENANCE INSTRUCTION	25
6.5.1	Preliminary operations.....	25
6.5.2	Making measurements.....	26
6.5.3	Conductivity calibration.....	26
6.5.4	TDS calibration.....	29
6.5.5	Temperature calibration.....	29
6.5.6	Setup.....	29
6.5.7	Maintenance of the transmitter.....	30
6.5.8	Maintenance of the sensor.....	30
6.6	INSTALLATION INSTRUCTION	31
6.6.1	Safety requirements.....	31
6.6.2	Configuration.....	31
6.7	OPERATING MODES.....	32
6.8	ANALOG MODE.....	32
6.9	DIGITAL OPERATION.....	33
6.9.1	Communication protocol.....	33
6.9.2	Modbus protocol.....	48
7	INSTALLATION DRAWINGS	57
7.1	Connections.....	57
7.2	Dimensions.....	58
7.3	Analog mode wiring.....	59
7.4	Digital mode wiring.....	60
8	WARRANTY.....	61
9	REPAIRS	61



1 GENERAL WARNINGS AND INFORMATION FOR ALL USERS

1.1 WARRANTY

This product is guaranteed for 5 years from the date of purchase for all manufacturing defects. Please take a look at the terms and conditions described on the warranty certificate at the end of the manual.

1.2 AFTER SALES SERVICE

Nieuwkoop B.V./B&C offers to all of its customers the following services:

- a free of charge technical assistance over the phone and email for problems regarding installation, calibration and regular maintenance;
- a repairing service in our Aalsmeer (Netherlands) headquarter for all types of damages, calibration or for a scheduled maintenance.

Please take a look at the technical support data sheet at the end of the manual for more details.

1.3 CE MARKING

This instrument is manufactured according to the following european community directives:

- 2011/65/EU "Restriction of the use of certain hazardous substances in electrical and electronic equipment"
- 2014/30/EU "Electromagnetic compatibility" EMC
- EN 61326-1/2013 "Electromagnetic compatibility" EMC
 - Industrial electromagnetic environment
- EN 55011/2009 "Radio-frequency disturbance characteristics"
 - Class A (devices for usage in all establishment other than domestic)
 - Group 1 (Industrial equipment that do not exceed 9kHz)

The  marking is placed on the packaging and on the S/N label of the instrument.

1.4 SAFETY WARNINGS

It is important to underline the fact that electronic instruments are subject to accidental failure. For this, it is important to take all necessary precautions to avoid damages caused by malfunctions.



Any operation must be performed by authorized and trained staff.

The use of this transmitter must comply with the parameters described in chapter "Technical data (page 12)", in order to avoid potential damages and a reduction of its operating life.

1.5 MANUAL REVISIONS

This chapter shortly describes the differences between previously released versions of the same manual, so to help users that are already familiar with the product.

Rev. B: Firmware R3.0
 Modbus RTU function 06 and 16
 ID+SN commands
 Bootloader function

Rev. A: Emission



2 PRODUCT OVERVIEW

2.1 FUNCTIONAL PURPOSE OF THE DEVICE

The system for monitoring of conductivity or salinity in terms of TDS consists of two main parts:

- the transmitter described in this instruction manual;
- the conductivity cell.

The instrument operates in analog and/or digital functionality (see chapter “Operating procedure”(page 22)).

The transmitter performs the following functions:

- display of the conductivity values of the aqueous solutions, by using a suitable measuring electrode;
- display of the temperature values, by using a Pt100 temperature sensor;
- perform the manual or automatic temperature compensation;
- operate in analog or digital mode;
- transmit the data of the main measurement and of the temperature on the serial interface
- connect to a master for remote configuration;
- activate the hold function of the current loop through an external free voltage contact.

2.2 ACCESSORIES

Sensors and accessories for different applications are available, to be ordered separately.

Our website www.meten.nl contains accessories, upgrades and detailed specifications of each product.

Our staff is always available to help costumers select the most appropriate and suitable solution for their specific needs.



3 INSTRUCTION MANUAL CONTENTS

This chapter describes the manual and gives suggestions to all users on how to read it and use it.

The manual is written according to the following norms:

- UNI 10893 "Instructions for use";
- UNI 10653 "Quality of product technical documentation".

The terminologies indicated in the international metrology vocabulary (VIM) are respected as far as possible.

3.1 SYMBOLS

Throughout the manual you may find the following symbols, which are both dictated by a norm or that are simply conventional.



WARNINGS: this symbol is used to warn users that if the instructions are ignored or not correctly followed, damage to the instrument can be caused.



NOTE: this symbol is to invite the user to pay particular attention to a specific section of the manual.

3.2 HOW TO READ THE INSTRUCTION MANUAL

The manual contains all the information needed to acquire full knowledge of the product, to ensure a proper installation, proper use and maintenance in order to achieve the desired result at the time of its choice.

The manual is aimed at staff with appropriate knowledge and experience in the field of measurement and control through the use of sensors and transmitters in the context of industrial plants.

The index of the manual refers the reader to the chapters on aspects that want to learn and develop.

In particular, the first chapters show general topics and allow the user to become familiar with the product, with its functional purpose and with the necessary accessories or options for its use.

The user can then check if he is in possession of all the elements necessary for the use of the instrument, of the measurement / regulation chain and of the use of the instruments connected to the network.

The instrument has been designed keeping in mind three different types of use: generic use (end user), control (maintenance staff), installation (plant engineer).



The user is normally interested on the display and will have to refer to the chapter:

- *"Instruction for the user (page 24)".*

The maintainer of the system, will be more interested in the chapters of the manual concerning:

- *"Instruction for the user (page 24)";*
- *"Maintenance instruction (page 25)";*
- *"Warranty (page 50)";*
- *"Repairs (page 50)".*

The plant engineer will have to make a complete reading of the chapters and consulting explanatory drawings in order to:

- *verify that the technical and functional characteristics are conformed with the plants requirements;*
- *verify that the environmental and climatic conditions required by the instruments are respected;*
- *make the correct electronic connections;*
- *become familiar with the instrument's firmware;*
- *configure the instrument according to the application;*
- *run all of the necessary tests before starting the instrument;*
- *calibrate the instrument once the sensor is connected.*



The data shown in the displays in this manual are only illustrative.

3.2.1 USING THE INSTRUMENT ON THE PLANT

For the generic use, the end user can operate with a locked keyboard (suggested mode and to be set by maintenance staff). By this, he can check the set point parameters without the possibility of changing the configured set points values and the zero/sensitivity calibration.

3.2.2 PLANT MAINTENANCE STAFF

Maintenance staff can select the operating values, by setting the desired parameters of the setup menu and after inserting the password. He can also enable the user's access to calibration, set point and alarm settings.

The location of this set parameters can be seen in the left column of the technical specifications table and they are identified by a letter "S" followed by a number.

The operations that need to be done during the start-up and the periodical tests are the following:

- to allow only the visualization of the measures during the normal use;
- to calibrate the sensors by means of ZERO and SENS keys;
- to set the following parameters:
 - response time of the filter software;
 - temperature measuring unit in °C or °F;



- manual temperature compensation;
- reference temperature for the temperature compensation;
- temperature coefficient;
- to modify the password to access the setup

3.2.3 INSTRUMENT INSTALLATION

The plant engineer, by inserting the access password and by setting and modifying the configuration parameters, will be able to select the necessary functions required by the plant.

The location of this set parameters can be seen in the left column of the technical specifications table and they are identified by a letter "C" followed by a number.

The operations that need to be done during the instrument installation are the following:

- K cell constant;
- measuring scale in function of the K cell;
- enable TDS scales and conversion factor;
- current loop enable/disable;
- scale factor 10/100%;
- baud rate of the RS485 interface;
- Nieuwkoop B.V./B&C or Modbus protocol ID;
- password to access the configuration.



4 SPECIFICATIONS AND TECHNICAL DATA

4.1 FUNCTIONAL SPECIFICATION

Display

The instrument is equipped with an alphanumeric LCD display 8x1 characters.

The display shows the measured values and messages which guide the operator in the use of the instrument.

The messages are alternating displayed.

Keyboard

The instrument has a 4 keys keyboard, which perform a dual function when pressed for more than 3 seconds allowing the access to all functions available. The combined pressure of a few buttons allows to perform additional functions described in specific points of the manual.

Inputs

The instrument is able to perform the measurement of conductivity, TDS and temperature.

The conductivity or TDS is measured by means of a cell with two or four electrodes. The temperature in °C or °F is measured by a 3-wire RTD Pt100.

Scale

The instrument allows the selection of four values of K cell.

For each value of K the user can choose 5 scales of conductivity as shown in the table in section "Technical data (page 12)".

With a selectable scale factor of 10% and 100% in configuration, it is possible to obtain intermediate scale values on the current loop.

If enabled in the configuration, the instrument can display for each scale the measure in terms of TDS in addition to the corresponding conductivity measurement by applying a conversion factor selectable from 0,450 to 1,000.

The transmitted record shows the TDS value even if the instrument has been configured for conductivity measurement.

Temperature compensation

The instrument displays the temperature value in the field $-10.0 \div 100.0$ °C or $14.0 \div 230.0$ °F and it performs the manual or automatic temperature compensation.

For absence or malfunction of the temperature sensor it automatically switches to manual compensation, by displaying the value of the compensation temperature.

The reference temperature can be chosen between two values (20 °C or 25 °C) commonly used by users.



Calibration

The operator can choose the calibration with standard KCl solutions, which are automatically recognized by the instrument, or the calibration with solutions other than KCl.

Depending on the choice, the instrument uses the thermocompensation coefficient of the KCl or the one set.

In calibration with standard KCl solutions, the KCl thermocompensation coefficient is maintained for 20 seconds after the calibration in order to check the correct calibration and then automatically switch to the predefined coefficient.

Analog output

The instrument operates in the current loop 4-20 mA proportional to the value of the principal measure.

The output is galvanically isolated, therefore directly interfaceable to a PLC, data acquisition cards or Nieuwkoop B.V./B&C instruments with 4/20 mA input.

Serial interface

Through the isolated RS485 interface, the user can connect the transmitter to a terminal or to a PC using a simple terminal emulation program. A RS485/RS232 or RS485/USB converter can be necessary.

Using B&C ASCII protocol, is possible measurements receiving, parameters setting and to calibration management.

Using Modbus protocol only functions 03, 06 and 16 are implemented for reading the measurements, changing the operating parameters and calibrating.

The MC6587 and MC7687 controllers from Nieuwkoop B.V./B&C allow complete management of the transmitter.

The bootloader function allows the firmware's update via serial port.

Software filter

A software filter with two selectable time constants operates on the sensor input signal.

The user can set the response time relative to the small or large variation signals separately, in order to obtain good reading stability and response speed to the variations of the measurement in the process.

Logic input

The instrument is equipped with a logic input which connects a free voltage contact from an external device.

The function of this input is to maintain in hold the current loop.

The state of the logic input is visible in the record digital broadcast.

Power supply

The instrument is powered (min. 9 Vdc ÷ max. 36 Vdc) through the current loop, directly from a PLC or data acquisition boards that provide the power, or by a power supply in series between the analog output and the apparatus of acquisition.

When operating in digital mode the instrument will be equally fed to the terminals of the current loop minimizing power consumption.



Setup

The instrument is provided with a setup menu protected by a specific password where you can:

- disable the calibration functions;
- choose the response time for the small/large software filter;
- select the unit of measurement of the temperature in °C or °F;
- select the parameters of the temperature compensation;
- change the access password.

In case the wrong password is entered, a message will appear and you can view the parameters but not modify them.

Configuration

The instrument is provided with a configuration menu protected by a specific password where you can select:

- the cell constant K;
- the measuring scale;
- the TDS enable and the conversion factor EC/TDS;
- the current loop enable;
- the scalability factor (10 ÷ 100%);
- the baud rate of the RS485 interface;
- the ID for communication protocols Modbus or B&C;
- a new value of the access password.

In case the wrong password is entered, a message will appear and you can view the parameters but not modify them.

Information menu

The instrument is provided with an information menu to show:

- p/n and firmware release;
- last calibration date;
- total operating hours.



4.2 TECHNICAL DATA

4.2.1 GENERAL SPECIFICATIONS

Room temperature	0 °C ÷ +50 °C
Relative humidity	up to 95 % without condensation
Protection of transmitter	IP40
Weight	250 g
Dimensions	71 x 95 x 58 mm
Mounting	Rail din 4 modules
Display	LCD COG 8x1 characters
Characters dimensions	11.97 x 4.97 mm
Long messages	sent alternately (title + variable)
Connections	removable terminal blocks 3.5 mm pitch
Isolation in/out	500 Vdc
Immunity performance loss	< 1 % full scale
EMC/RFI conformity	EN61326
Registered design	002564666-001



4.2.2 TECHNICAL SPECIFICATION

In the left column indicates the number of the display concerned:

- SETUP parameters are indicated by "S xy"
- CONFIGURATION parameters are indicated with "C xy" where
 x = paragraph y = sequential 1..2..3..4..ecc

D1.0	MEAN MEASURE				Default		
D0.5	Measure	TDS (if enabled)			Conductivity		
D1.0		Conductivity					
	Input	cell 2 / 4 wires					
		The use of cables longer than 5 meters with 4 electrodes cells is not recommended					
C1.1	K cell	0.1 / 0.5 / 1.0 / 10			1.0		
C1.2	Scales	1	2	3	4	5	
	K=0.1	2.000 µS / 20.00 µS / 200.0 µS / 2000 µS / 20.00 mS					
	K=0.5	10.00 µS / 100.0 µS / 1000 µS / 10.00 mS / 100.0 mS					
	K=1.0	20.00 µS / 200.0 µS / 2000 µS / 20.00 mS / 200.0mS					2000 µS
	K=10	200.0 µS / 2000 µS / 20.00 mS / 200.0 mS / 2000mS					
	Scales	Resolution	Measure	Reading limits			
	2.000 µS	0.001	-0.100 / 2.100		-0.200 / 2.200		
	10.00 µS	0.01	-0.50 / 10.50		-1.00 / 11.00		
	20.00 µS	0.01	-1.00 / 21.00		-2.00 / 22.00		
	100.0 µS	0.1	-5.0 / 105.0		-10.0 / 110.0		
	200.0 µS	0.1	-10.0 / 210.0		-20.0 / 220.0		
	1000 µS	1	-50 / 1050		-100 / 1100		
	2000 µS	1	-100 / 2100		-200 / 2200		
	10.00 mS	0.01	-0.50 / 10.50		-1.00 / 11.00		
	20.00 mS	0.01	-1.00 / 21.00		-2.00 / 22.00		
	100.0 mS	0.1	-5.0 / 105.0		-10.0 / 110.0		
	200.0 mS	0.1	-10.0 / 210.0		-20.0 / 220.0		
	2000 mS	1	-100 / 2100		-200 / 2200		
S1.2	RT 90 % large signal	1÷ 20 seconds			2 s		



D1.0		MEAN MEASURE			Default
S1.3	RT 90% small signal	1 ÷ 20 seconds			10 s
	Measure update	0.5 s			
D1.1	Zero	±10 % of the scale			0 %
	Calibration	the zero calibration is done automatically on all scales from the lowest one			
D1.2	Sensitivity	60 ÷ 160 %			100 %
	Calibration	Man / auto with KCl standard solutions			
	Solutions KCl	0.01 N	0.1 N	1 N	
	Tref 20 °C	1278 µS	11.67 mS	102.1 mS	
	Tref 25 °C	1413 µS	12.88 mS	111.8 mS	
	TC during calibratio	TC of the standard solution			
C1.3	Scales TDS	On / Off			Off
C1.4	Conversion factor TDS/EC	0.450 / 1.000 1/s			0.670
		Scale EC	TDS scale	Resolution	
		2.000 µS	1.000 ppm	0.001 ppm	
		10.00 µS	5.00 ppm	0.01 ppm	
		20.00 µS	10.00 ppm	0.01 ppm	
		100.0 µS	50.0 ppm	0.1 ppm	
		200.0 µS	100.0 ppm	0.1 ppm	
		1000 µS	500 ppm	1 ppm	
		2000 µS	1000 ppm	1 ppm	
		10.00 mS	5.00 ppt	0.01 ppt	
		20.00 mS	10.00 ppt	0.01 ppt	
		100.0 mS	50.0 ppt	0.1 ppt	
		200.0 mS	100.0 ppt	0.1 ppt	
		2000 mS	1000 ppt	1 ppt	



D2.0	SECONDARY MEASURE		Default
D2.0	Measure	Temperature	
	Input	RTD Pt100 3 wires	
S2.1	Measuring unit	°C / °F	°C
	Temperature compensation	manual without RTD automatic with RTD	
	Scales	-10.0 ÷ 110.0 °C 14.0 ÷ 230.0 °F	
	Resolution	0.1 °C / °F	
	Zero	± 5.0 °C ± 9.0 °F	0.0 °C 0.0 °F
S2.2	Manual temperature	0.0 ÷ 100.0 °C 32.0 ÷ 212.0 °F	20.0 °C 68.0 °F
S2.3	Reference temperature	20 / 25 °C	20 °C
S2.4	Temperature coefficient	0.00 ÷ 3.50 %/°C	2.20 %/°C

	CURRENT LOOP		Default
C5.1	Current loop	Enabled / Disabled	Enabled
	Current loop proportional to the measure	4-20 mA	
C5.2	Scalability factor	10 ÷ 100%	100%
	Under range	3.80 mA	
	Over range	20.80 mA	
	ID of the selected scale (current loop enabled)		
	• Scale 1	11 mA at switching on for 8"	
	• Scale 2	12 mA at switching on for 8"	
	• Scale 3	13 mA at switching on for 8"	
	• Scale 4	14 mA at switching on for 8"	
	• Scale 5	15 mA at switching on for 8"	



DIGITAL OPERATION			Default
	Protocols	B&C protocol ASCII / Modbus RTU The two protocols can coexist	
C8.2	Nieuwkoop B.V./B&C ID protocol	ID=01 ÷ 99 last s/n digit, if 0 ID=10	01 ÷ 10
C8.3	Modbus address	ID=01 ÷ 243 last s/n digit, if 0 ID=10	01 ÷ 10
Measures and parameters are provided under interrogation (see protocols B&C ASCII and Modbus RTU function 03 – 06 – 16)			

SERIAL INTERFACE			Default
	Interface	RS485 isolated not terminated	
C8.1	Baud rate	2400 / 4800 / 9600 / 19200 baud	9600 baud
	Distance of connection	1000 / 500 / 250 / 125 m	
	Use in network	32 transmitters max	

DIGITAL INPUT			Default
	Digital input	free voltage contacts in closure	
	Digital function	hold of the loop 4-20 mA (The input state is visible on the digital protocols)	

D50.0	SETUP		Default
50.1	Password to access the setup	000 ÷ 999	000
S1.1	Calibration inhibition	On / Off	Off
S1.2	RT 90 % large signal	1 ÷ 20 seconds	2 s
S1.3	RT 90 % small signal	1 ÷ 20 seconds	10 s
S2.1	Temperature measuring unit	°C / °F	°C
S2.2	Manual temperature	0 ÷ 100 °C 32 ÷ 212 °F	20 °C
S2.3	Reference temperature	20 / 25 °C	20 °C
S2.4	Temperature coefficient	0.00 ÷ 3.50 %/°C	2.20 %/°C
S50.0	Password changing	000 ÷ 999	000

D60.0	CONFIGURATION		Default
60.1	Password to access the configuration	000 ÷ 999	000
C1.1	K of cell	0.1 / 0.5 / 1.0 / 10	1.0
C1.2	Conductivity scales		



D60.0 CONFIGURATION		Default
K=0.1	2.000 / 20.00 / 200.0 / 2000 μ S 20.00 mS	
K=0.5	10.00 / 100.0 / 1000 μ S 10.00 / 100.0 mS	
K=1.0	20.00 / 200.0 / 2000 μ S 20.00 / 200.0 mS	2000 μ S
K=10	200.0 / 2000 μ S 20.00 / 200.0 / 2000 mS	
C1.3	TDS scales	On / Off
C1.4	Conversion factor TDS/EC	0.450 \div 1.000
C5.1	Current loop	Enabled / Disabled
C5.2	Scalability factor	10 \div 100%
C8.1	Baud rate	2400 / 4800 / 9600 / 19200 bit/s
C8.2	B&C ID protocol	ID=01 \div 99 last s/n digit, if 0 ID=10
C8.3	Modbus address	ID=01 \div 243 last s/n digit, if 0 ID=10
C60.0	Password changing	000 \div 999

D70.0 INFO MENU		Default
I1.0	P/N and firmware release	C3436 Rev3.xx
I2.0	Scale / Last calibration date	Scale / XX/XX/XX
I3.0	Total hours of operation	XXXXXX h

POWER SUPPLY		Default
Voltage	min 9 Vdc / max 36 Vdc	
Current - current loop disabled	< 4 mA a 9 Vdc (in absence of communication)	
Current - current loop enabled	4-20 mA, 21 mA max	
The current can be higher during the communication		



5 INSTALLATION

5.1 PACKING LIST

The package contains:

- N°1 unit with serial number label;
- N°1 instruction manual.

5.2 PACKING AND UNPACKING

- 1 Open the carton box and keep it.
- 2 Remove the instrument for the carton box.
- 3 Remove the plastic protection from the instrument.
If repackaging do the reverse.

5.3 STORAGE AND TRANSPORT

For prolonged storage, keep the product in dry places.
In case of transportation, pack the product in a carton box.

5.4 INSTALLATION OF THE TRANSMITTER

The instrument can be installed in a watertight box or in an electrical control panel with a DIN rail .

5.5 INSTALLATION OF THE SENSOR

The conductivity cell must be mounted correctly if you want the system to work accurately and efficiently.

In particular, note the following:

- the sample in contact with the cell must be representative of the solution to be measured;
- the liquid must flow continuously through the cell; if the cell is submersed, the liquid should be shaken;
- the assembly of the cell must be such as to prevent stagnation of air bubbles on the electrodes; typically a 45° or installation in a pipe with the electrodes invested by the flow does not create problems;
- sediment or deposits must not accumulate in the electrodes area;
- verify that the limitations of temperature and pressure of the cell met by the fluid under measurement.



Check that the type of cell is appropriate for the selected range, and that the cable is adequate for the distance between the cell and the instrument.

Low conductivity values may require the use of a special cable (eg . the model SZ 927.1) and special connection with the instruments installed at large distances from the cell. (contact our sales department for advice and assistance in special applications).

5.6 ELECTRICAL INSTALLATION

For all electrical connections, refer to the label on the instruments, also shown and described in chapter "Installation drawings (page 57)".

All the connections to the instrument are made using removable terminal blocks.



It should be remembered that the electronic instruments are subject to accidental failure.

Predict the necessary precautions to avoid any damage caused by their dysfunction.

5.6.1 CONNECTION OF THE MEASURING CELL

The connection of the cell is the most critical part of the whole system.

The application of accidental voltages can damage the circuitry of the input amplifier.

- Use low loss cables over the entire length between the cell and the input terminals of the instrument.
- Avoid interruptions of the cable. If necessary use junction box with very high insulation and protect from moisture.
- Keep the cell cable far from the power cables inside the electrical panel also.
- Very long connections may require compensation of the "zero" when measuring low values of conductivity.

Two-electrodes cell connection

- Connect the cell between terminals 10 and 11 marked A and D.
- Verify the presence of a jumper between terminals 9 and 10 (marked B and A) and one between terminals 11 and 12 (marked D and C). Install them in case they have been removed.
- If the cell cable is coaxial, connect the central to terminal 11 (input) marked D (C1) and connect the shield to terminal 10 (output) marked A (CO).
- If the electrodes of the cell are either coaxial or concentric, connect the central electrode to terminal 11 (input) marked D (C1) and connect the outer electrode to terminal 10 (output) marked A (CO).

Four-electrodes cell connection

- Remove the jumper between terminals 9 and 10 (marked B and A) and the jumper between terminals 11 and 12 (marked D and C).
- Connect the voltage electrodes to the terminals 9 and 12 (marked B and C).
- Connect the current electrodes to the terminals 10 and 11 (marked A and D).



The use of cables longer than 5 meters is not recommended.
Contact our Sales Department for more information.

Refer to the cell's instruction manual to identify the voltage and current electrodes.

5.6.2 CONNECTION OF THE TEMPERATURE SENSOR

To display the temperature value and for the automatic compensation of the effect of temperature on the conductivity measurement it is necessary to connect the temperature sensor Pt100 RTD as shown in chapter "Installation drawings (page 57)", using the appropriate wire section.

If the temperature sensor is not connected, or is interrupted or in short circuit, the instrument automatically switches to the manual temperature compensation.

Two-wire Pt100 connection for short distances

- Connect the Pt100 to terminals 13-14 (marked T1-T2) and short terminals 14-15 (marked T2-T0).

Three wire Pt100 connection for great distances

- Connect a Pt100 wire to the terminal 13 marked T1.
- Connect one common wire of the Pt100 to terminal 14 (marked T2) and the other common wire to terminal 15 (marked T0) using two separate wires.



Do not interrupt the connection cable.
Use extension cable through high isolation junction box; Keep the cable away from the power cables.

5.6.3 CONNECTION OF THE CURRENT LOOP

The instrument provides an output current proportional to the primary measure to drive an external recorder, PLC or other similar devices.

- Connect the (+) terminal of the power supply to the terminal 3 marked ±.
- Connect the return of the loop (-) to the terminal 2 marked ∓.

If the analog signal must drive more devices, they must be connected in "series" with each other, respecting the maximum value of resistance as a function of the supply voltage.

5.6.4 CONNECTION OF THE LOGIC INPUT

The free voltage contacts in closure from an external device must be applied to the logic input terminals 7 and 8 marked GND and D1.



Do not give any power to the logic input terminals.



5.6.5 CONNECTION TO THE RS485 SERIAL PORT

The instrument can be configured as a slave device and communicate via the serial port. There are two types of protocol as described in chapter "Digital operation (page 33)".

- Connect the positive differential of the RS485 interface to terminal 5 marked A+.
- Connect the negative differential of the RS485 interface to terminal 6 marked B-.
- Connect the eventual ground of the RS485 interface to terminal 7 marked GND.

5.6.6 NETWORK CONNECTION (RS485)

These digital transmitters use a RS485 driver with slow switching fronts.

This implies that it is not necessary to complete the termination of the transmission line even for long distances.

The following directions are to be considered as examples.

If the driver of the master device has very fast switching fronts, it may be necessary to terminate the beginning and end of the transmission line.

In this case it should be inserted in the transmission line an AC termination by inserting a capacitor in series with the terminating resistor at the beginning and end of the transmission line.

The purely resistive termination is not tolerated by the transmitter as the internal power supply does not support high loads.

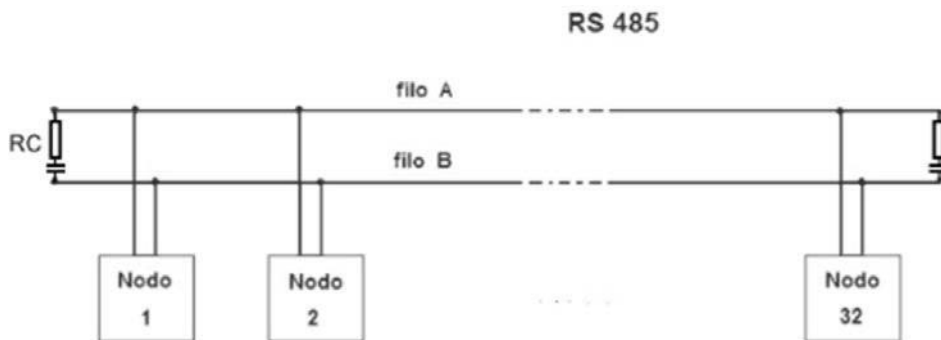

By way of example, the value of the capacitor will have the following values depending on the length of the line: 10nF (150 m) – 22 nF (300 m)- 47 nF (600 m) – 100 nF (1000 m).

5.7 DISPOSAL

In case of disposal of the instrument, apply the terms of the law provided for the disposal of electronic devices.



6 OPERATING PROCEDURE

6.1 OPERATING PRINCIPLES

The instrument is used for measuring the electrical conductivity of a liquid; the conductivity depends on the ionic concentration in solution.

The measurement of TDS is calculated by applying a conversion coefficient to the conductivity measurement, the value of which is chosen depending on the type of salt present in the solution.

The conductivity measurement is carried out using a cell with 2 or 4 electrodes featuring defined geometric dimensions, completely surrounded by the liquid, to which is applied an alternating voltage of suitable frequency to avoid polarization of the same caused by electrochemical effects.

The method of measurement used in the cell with 4 electrodes minimizes the polarization of the electrodes and the measuring error for electrodes dirty.

The geometry of the electrodes defines the cell constant, normally indicated with "K".

Normally are used cells having the value $K=1$, but this transmitter can be operated with conductivity cells having values of $K=0.1$ - $K=0.5$ - $K=1$ - $K=10$ to obtain measurement scales in a very wide range.

The type of material used for the construction of the electrodes limits the choice of the measuring scale normally declared in the specification of the cell itself.

The temperature of the solution has a major influence on the measure because it depends on the activity of ionic substances dissolved in the sample.

There is therefore an increase in conductivity with increasing temperature even if the content of the sample remains unchanged.





In many cases it is important to have a measurement of conductivity independent of temperature and referred to a conventional temperature (20 °C or 25 °C); in this case it is necessary to use the automatic compensation of the effect of temperature, by detecting the temperature with a sensor immersed in the sample for the electronic correction of the conductivity value detected.

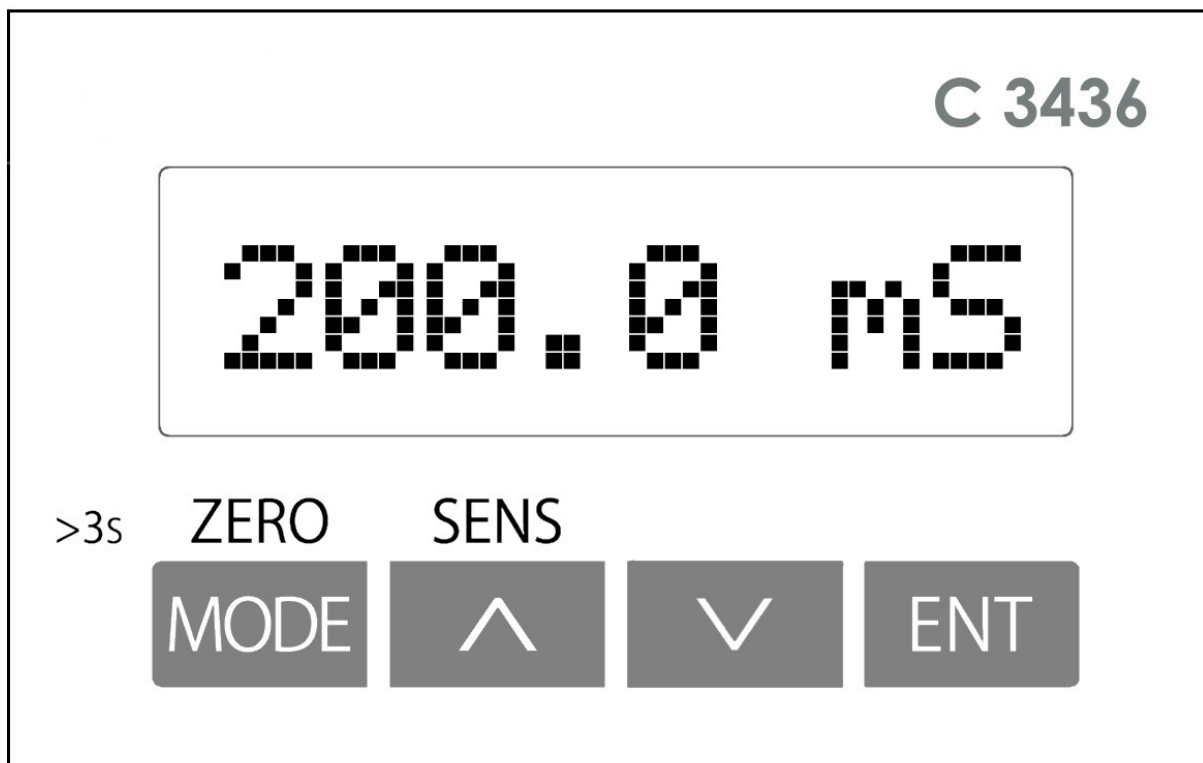

6.2 DISPLAY



6.2 KEYS

KEY	FUNCTION
<p>ZERO</p> 	<p>Key MODE/ZERO</p> <ul style="list-style-type: none"> - Visualize the sequence of the functions - Exit without changing the visualized value - >3s Start the zero calibration
<p>SENS</p> 	<p>Key UP/SENS</p> <ul style="list-style-type: none"> - Increase the value - Access to the parameter changing - >3s Start the sensitivity calibration
	<p>Key DOWN</p> <ul style="list-style-type: none"> - Decrease the value - Access to the parameter changing
	<p>Key ENTER</p> <ul style="list-style-type: none"> - Confirm the visualized value - Go to the next parameter (in setup and configuration) - Access to the secondary menu and parameters - >3s Activate and deactivate the hold function



6.4.4 PARAMETERS RESERVED TO THE PLANT MAINTAINER

From this display the user can access the maintenance menu of the instrument (setup) via password.



6.4.5 PARAMETERS RESERVED TO THE PLANT ENGINEER

From this display the user can access the installation menu of the instrument (configuration) via password.

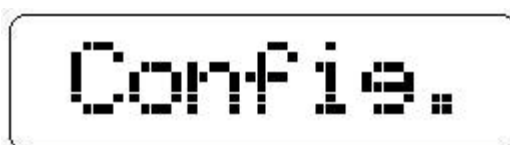

6.4.6 INFORMATION DISPLAY

From this display the user can access the information of the instrument.



- ENT -to access to the functioning informations
- to set/visualize the last calibration date
- to visualize the total hours of operation

MODE to access to the main measurement display (TDS or conductivity).

6.5 MAINTENANCE INSTRUCTION

6.5.1 PRELIMINARY OPERATIONS

Any checking operation must be done with the cell or an adequate resistance connected to the input of the device.

In particular, check that the instrument has been properly configured for the type of use.

To verify the parameters without modifying them follow the operating procedures described in paragraph "Setup (page 29)".

The display provides all the information necessary for the preliminary checks of operation.

The lighting of the display indicates that the unit has power and power circuits are working properly.



6.5.2 MAKING MEASUREMENTS

To operate the system installed, verify the connection of the following components:

- the conductivity cell and the eventual RTD in contact with the liquid under test;
- the logic input if necessary.

Provide the power to the current loop and read the conductivity value of the liquid under test.

If the sensors are connected properly, as described in chapter "Installation (page 18)", the system will operate on a regular basis and require only the calibration.

6.5.3 CONDUCTIVITY CALIBRATION

Install the conductivity cell and connect it to the instrument.

If necessary the zero calibration is done as follows:

- remove the cell from the liquid, and verify that the display value is zero;
- if the value is different from zero, adjust to zero the display by means of the calibration procedure described below.

MODE (ZERO) by pressing this button for more than 3 seconds, the message **Zero Cal** appears alternately to the actual conductivity value or **Cal lock** if the calibration was inhibited in the setup (Display S1.1).

ENT starts the automatic calibration, the display shows **Zeroing** alternating with **Scale x** where **x** will assume the values of 5 to 1 to indicate the zeroing of the five scales.

If the zero value is proposed outside the acceptable limits described in the technical specifications, the display will show the error message **Zero Err.**

ENT to delete the message and return to the main display.

If the new value is accepted, the display will show for a few seconds the message **UPDATE.**

 *The reset to zero factory in the main display is done as follows:
start the calibration of zero, simultaneously press the UP, DOWN and ENT; the message **RES Zero** will appear for a few seconds.*

The sensitivity calibration is carried out through the use of standard solutions, considering the temperature value (see attached table). Operate in the following way:

- prepare a standard solution of KCl (see table) or use solutions at known conductivity;
- immerse the cell in the solution and follow the procedure for calibrating the sensitivity described below.

UP (SENS) by pressing this button for more than 3 seconds, the message **Sens typ** appears alternately to the message **KCl std** or **Cal lock** if the calibration was inhibited in the setup (Display S1.1).

UP/DOWN to select the calibration type.



KCl STD: if you choose to calibrate with the standard KCl solution, the instrument performs the calibration by applying the KCl temperature coefficient which may be different from that set for the temperature compensation of the sample in question. At the end of the calibration the coefficient is maintained for 20 seconds.

MEAS ADJ: if you choose to calibrate the conductivity value by comparison, the instrument performs the calibration by applying the temperature coefficient set for the sample in question.

ENT to confirm the selection.

The display will show the measured value **xx.xx mS**.

UP/DOWN to modify the value.

KCl std calibration: if the measured value is close to the standard solution's value, the store value will be proposed.

ENT to confirm the entered value.

MODE to return to the main display without entering the sensitivity.

If the new value exceeds the limits of acceptability shown in the technical specifications of the instrument, the error **Sens Err** will appear.

ENT to delete the error message and return to the main display.

If the new value is accepted, the display will show for a few seconds the message **UPDATE**.



*The reset to sensitivity factory in the main display is done as follows: start the calibration of sensitivity, select the calibration type and simultaneously press the UP, DOWN and ENT; the message **RES Sens** will appear for a few seconds.*

If the measured value is different from that expected in the process can mean that:

- the real value of the solution used is very different from the nominal one (the solution is polluted or altered);
- the conductivity cell is not operating properly;
- the configuration of the cell K is not correct.

In many applications, it is sufficient to perform only the sensitivity calibration using standard solution value closest to the conductivity of the sample to be measured, periodically checking the zero value with the sensor dry in air.



The two error messages provided by the instrument during the calibration indicate that the cell is in unacceptable operating condition (and therefore risky for the plant).

In fact, a zero deviation $> 10\%$ **Zero Err** is an indication of excessive electrodes pollution or problems on the cable.

A deviation of sensitivity $< 60\%$ or $> 160\%$ **Sens Err** indicates a wrong K of the cell, damages or other.

In the case of these reports is advisable to replace the cell or the cable and check the connections.

CONDUCTIVITY STANDARD SOLUTIONS			
KCl CONCENTRATION	1 N	0,1 N	0,01 N
Temperature °C			
0	65.410	7.150	0.776
5	74.140	8.220	0.896
10	83.190	9.330	1.020
15	92.520	10.480	1.147
16	94.410	10.720	1.173
17	96.310	10.950	1.199
18	98.220	11.190	1.225
19	100.140	11.430	1.251
20	102.070	11.670	1.278
21	104.000	11.910	1.305
22	105.940	12.150	1.332
23	107.890	12.390	1.359
24	109.840	12.640	1.386
25	111.800	12.880	1.413
26	113.770	13.130	*
27	115.740	13.370	*
28	*	13.620	*
29	*	13.870	*
30	*	14.120	*

The conductivity values are expressed in μS .

Use KCl (potassium chloride) pure for analysis and distilled water.

1 N solution: Dissolve 74.59 grams of KCl in 1 liter of distilled water.

Always use freshly prepared solutions.



6.5.4 TDS CALIBRATION

The calibration of the TDS is made by choosing the appropriate conversion coefficient EC/TDS in order to obtain on the display the value in ppm or ppt concentration.

It is suggested to set the value of the conversion coefficient after the calibration of the conductivity.

6.5.5 TEMPERATURE CALIBRATION

It can be made when the Pt100 sensor is connected.

Immerse the Pt100 in a liquid or keep the sensor in the air knowing the value of the temperature.

MODE press the key from the main display to go to D2.0 display.

MODE (ZERO) press the key for more than 3 seconds.

The message **Zero cal** will appear alternately with the temperature value. Wait for the stabilization of the temperature value on the display.

UP/DOWN to modify the values.

The display will show the actual value **XXX.X °C** or **°F**.

UP/DOWN to modify the value.

ENT to confirm the entered value.

MODE to return to the main display without modify the values.

The message **Update** indicates the calibration is memorized.

If the new value exceeds the limits shown in the specification, the message **Zero Err** will appear.



*The reset to factory value in the main display is done as follows:
start the calibration of temperature, simultaneously press the UP, DOWN and ENT; the message **RES Zero** will appear for a few seconds.*

6.5.6 SETUP

MODE press the key two times from 1.0 display to get the message Set-up (display 50.0).

ENT to scroll through the setup functions.

UP/DOWN to change the value or the option visualized on the display.

ENT to confirm the changings; the message UPDATE will appear.

MODE to exit from the procedure and to turn to the 50.0 display.



Display	Content	Meaning	Possible values
50.1	PASS 000	Password to access the setup menu	000 ÷ 999
S1.1	Cal lock	Inhibition of the zero and sensitivity calibration	On Off
S1.2	RT large	Response time of the filter software large signal	1 ÷ 20 s
S1.3	RT small	Response time of the filter software small signal	1 ÷ 20 s
S2.1	T Unit	Measuring unit of the temperature	°C °F
S2.2	T man	Manual temperature values	0.0 ÷ 100.0 °C 32.0 ÷ 212.0 °F
S2.3	Temp.Ref	Reference temperature setting	20 / 25 °C
S2.4	Temp. Co	Temperature coefficient	0.00 ÷ 3.50 %/ °C
S50.0	Set-up	Password setting	000 ÷ 999



If the password is incorrect, the message "**WRONG PW**" will appear for 2 seconds and you can view the parameters but not modify them.

6.5.7 MAINTENANCE OF THE TRANSMITTER

The use of electronic components of high quality gives the instrument characteristics of great reliability.

The frequency of any maintenance depends on the particular use of the instrument.



Disconnect the power supply to the unit before performing the following procedures:

- dust removal from the terminal;
- operations on the wires connecting the terminal;
- mounting of the instrument in the switch board.

As with any electronic device mechanical components such as buttons and terminal blocks are the most prone to failure.

- Periodically check that the device is not subject to excessive moisture.
- Check that the connections to the terminal are free of dust and corrosion.
- Check that the terminal screws are tight.

6.5.8 MAINTENANCE OF THE SENSOR

The instrument can provide incorrect measurements due to the sensor which must be carried out proper maintenance by following the instructions in its specific manual.

The cell must be inspected and cleaned regularly, most frequently in the case of applications in alkaline liquids or fat-containing or organic substances.

Periodically, according to the needs of the application, it is suggested to perform the calibration operations.



6.6 INSTALLATION INSTRUCTION

6.6.1 SAFETY REQUIREMENTS



After performing the installation (chapter "Installation (page 18)"), before switching on and configuring the instrument do the following operations:

- check that all connections are correct;
- check that all connections are fastened on the terminal;
- check that the mechanical attachment of the cables does not cause any twisting or bending on the terminal blocks.



The damage due to incorrect connections during installation are not covered by warranty.

6.6.2 CONFIGURATION

MODE	press the key three times from 1.0 display to get the message Config. (display 60.0).
ENT	to scroll through the configuration parameters.
UP/DOWN	to change the value or the option visualized on the display.
ENT	to confirm the changings; the message UPDATE will appear.
MODE	to exit from the procedure and to turn to the 60.0 display.



Depending on the configuration of the instrument configuration parameters may not be displayed.

Display	Contents	Meaning	Possible values
60.1	PASS 000	Password to access the configuration menu	000 ÷ 999
C1.1	K CELL	K cell selection	0.1/0.5 1.0/10
C1.2	EC scale	Scale selection	See chapter "Technical data (page 12)"
C1.3	TDS meas	TDS scale activation	On Off
C1.4	TDS fact	TDS/EC conversion factor	0.450 ÷ 1.000
C5.1	LOOP	Current loop enable/disable	enable disable
C5.2	Scalable	Scale factor	10 ÷ 100 %
C8.1	BaudRate	Baud Rate selection	2400 / 4800 9600 / 19200
C8.2	B&C ID	ID for the B&C protocol	01 ÷ 32



Display	Contents	Meaning	Possible values
C8.3	ModbusID	ID for the modbus protocol	01 ÷ 243
C60.0	Config.	Password setting	000 ÷ 999

 *If the password is incorrect, the message "WRONG PW" will appear for 2 seconds and you can view the parameters but not modify them.*

6.7 OPERATING MODES

The transmitter can be configured to operate in analog mode (current loop 4-20 mA = enable). The digital mode is always active.

 *In order to reduce the power consumption, the user can disable the current loop and operate only in digital mode.*

6.8 ANALOG MODE

In analogue mode the transmitter provides a 4-20 mA output current loop isolated from the sample for direct connection to a PLC or to a data logger.

The transmitter can be connected to a PLC or instruments BC 7335 – BC 7635 – BC 7687-BC 6587 B&C/Nieuwkoop, which allow the visualization of the measure and have two set point on/off and an alarm window.

The transmitter is supplied with the factory configuration in analogue mode (loop = enable).

When switched on the transmitter will provide for 8 seconds a current value that allow the operator to identify the scale of measurement selected in the configuration:

- 11 mA for scale 1;
- 12 mA for scale 2;
- 13 mA for scale 3;
- 14 mA for scale 4;
- 15 mA for scale 5.

Subsequently, the transmitter starts supplying the 4-20mA signal proportional to the measurement on the loop.

To carry out the measurement calibration operations without altering the 4-20mA signal used in the process (for example connected to a PLC) it is possible to activate the hold function which "freezes" the value of the loop signal.

The hold function on the 4-20mA loop can be activated/deactivated:

- by closing / opening a contact on the digital input;
- from the keypad holding ENT for 3 seconds from the main display.

The keyboard-enabled hold feature has a 30-minute timeout.



6.9 DIGITAL OPERATION

In digital mode the transmitter is a slave device that interacts with a master device. Through the RS485 interface the transmitter can be connected to a master device.

To connect to a PC a RS485/RS232 or RS485/USB converter (like Nieuwkoop/B&C's BC 8701) can be required.

The communication takes place via the RS485 connection with the B&C protocol (ASCII) and Modbus RTU (function 03, 06, 16) protocol described in the following chapters.

The transmitter can be connected to the MC 7687 – MC 6587 Nieuwkoop/B&C controllers, which provide power supply, perform remote display and adjustment functions and allow complete management of the transmitter itself.

6.9.1 B&C COMMUNICATION PROTOCOL

Connect the transmitter to a PC for data management and calibration, using a simple terminal emulation program (example Hyperteminal).

Mode of transmission

Code system	ASCII
Number of bits per character:	
- start bits	1
- data bits	8
- parity	no parity
- stop bits	1
Error check (only A command)	BCC
Speed	9600 baud (default)

Command format using ID (01÷ 99)

1 or 2 byte ID transmitter (01 ÷ 99) 1 or 2

byte of command

n bytes of data to insert if requested by the command

1 byte <cr> (carriage return), end of the command

The transmitter transmits only if the ID sent is correct or is 00.



Do not use 00 ID if more than one transmitter is connected, to avoid overlap of the communication.

Command format using ID + SNxxxxxx

1 or 2 byte ID transmitter (01 ÷ 99) 8 byte

serial number (SNxxxxxx)

1 or 2 byte of command



n byte to be inserted if required by the command

1 byte <cr> (carriage return) end command

The transmitter transmits only if the ID + serial number is sent correct or if it is 00 + serial number.



If the communication port is set to a different speed the transmitter will not communicate.



The available commands are listed in the following pages.



The list of commands implemented in the transmitter is always available by sending the command Help.

COMMANDS USING ID

HELP

Command format: **ID + H <cr>**

Example: if ID=14 type 14H <cr> or 00H <cr>

By sending the command **H** displays the list of available commands with a brief description of their meaning.

```

-----
HELP MENU, COMMAND LIST          B&C ELECTRONICS
-----
C3436 CONDUCTIVITY TRANSMITTER Rev.fw:3.00  S/N:160589

00H <cr>  Help menu
00A <cr>  Acquisition
00Lx <cr>  Current loop:      0001          (0=disable 1=enable)
00Kx <cr>  K cell:           0003          (1=K0.1 2=K0.5 3=K1 4=K10)
00Ox <cr>  Analog out 4/20mA: 0003          (1-5=scale K*(20uS-200mS))
00Xx <cr>  Scalable output %: 0100          (10-100% full scale)
00Mx <CR>  Scale TDS:        0000          (0=EC 1=TDS)
00Fx <cr>  TDS/EC factor     0.670        (0.450-1.000)
00RLx<cr> RT90% large signal 0002 s      (1-20s)
00RSx<cr> RT90% small signal 0010 s      (1-20s)
00Wx <cr>  Temp. unit        0001          (1=°C 2=°F)
00Jx <cr>  Temp. adjust      not done    0.0    (5.0°C/9.0°F max) (00JR reset)
00Nx <cr>  Tman              20.0 °C    (0.0-100.0°C / 32.0-212.0°F)
00Gx <cr>  Tref              0001          (1=20°C 2=25°C)
00Cx <cr>  TC                2.20 %/°C  (0.00-3.50%/°C)
00Vx <cr>  Meas. with KCl TC: 0000          (0=no 1=yes momentary)
00Tx <cr>  Standard solution: 0000          (0.000-2000)
00Ux <cr>  Std. measure unit: 0001          (1=uS 2=mS)
00Z <cr>  Zero calibration:  not done    0    (10% fs max) (00ZR reset zero)
00S <cr>  Sens. calibration:  not done   100.0% (60-160%) (00SR reset sens)
00Dx <cr>  Last cal date:    00/00/00    (XX/XX/XX, XX=00-99)
00Ix <cr>  ID B&C:          0009          (01-99)
00Ex <cr>  ID modbus:       0009          (01-243)
00Bx <cr>  Baud rate:       0003          (1=2400 2=4800 3=9600 4=19200)

Type ID number or 00 before command. Example, if ID=15 type 15A or 00A <cr>
Use 00A <cr> if only one probe is connected
Query commands: 00H?,00Z?,00S?,00J?
-----

```



PARAMETERS QUERY

Command format: **ID + H? <cr>**

Example: if ID=14 type 14H? <cr> or 00H? <cr>

By sending the command **H?** displays a record containing the code and the identifier followed by all parameters including the results of calibrations.

The record transmitted uses the “,” as separator.

Record format:

```
C3436- 02,FW:3.00,SN:123456,L:0001,K:0003,O:0003,X:0100,M:0001,F:0.50
.....|.....|.....+.....|.....+.....|.....+.....|.....+.....|.....+.....|
0,RL:0002,RS:0010,W:0001,J:not done ± 0.0°C ,N: 20.0 °C ,G:0001,C:
.....|.....+.....|.....+.....|.....+.....|.....+.....|.....+.....|.....+.....|
2.20,V:0000,T:0000 ,U:0001,Z:not done ± 0.00mS ,S:not done 100.0%
.....|.....+.....|.....+.....|.....+.....|.....+.....|.....+.....|.....+.....|
 ,D:00/00/00,IA:0002,EA:0002,BA:0003,BCC:4BB8,xx
.....+.....|.....+.....|.....+.....|.....+.....|.....+.....|.....+.....|.....+.....|
```

C3436	Transmitter code
02	Transmitter identification number

Below are transmitted parameter values measured by the transmitter with the format
NAME PARAMETER: VALUE.

FW:3.00	Firmware version
SN:123456	Transmitter serial number
L:0001	Current loop enable
K:0003	K Cell
O:0003	Analog output/scale setting
X:0100	Scalable output
M:0001	TDS scale
F:0.500	TDS factor
RL:0002	Large software filter value
RS:0010	Small software filter value
W:0001	Temperature measuring unit
J:not done 0.0 °C	Temperature calibration outcome
N:20.0 °C	Manual temperature
G:0001	Reference temperature
C:2.00%/°C	Temperature coefficient
V:0000	Measure with KCl TC
T:0000	Standard solution value
U:0001	Standard solution measure unit
Z:not done 0.00mS	Zero calibration outcome



S: not done 100.0%	Sensitivity calibration outcome
D: 00/00/00	Last calibration date
IA: 0009	ID B&C protocol
EA: 0009	ID Modbus protocol
BA: 0003	Baud rate
BCC: 4BB8	BCC EEPROM check
xx	2 byte BCC of transmitted record

The record transmission is ended by <cr> <lf>.

EEPROM BCC check use

The EEPROM BCC check is a summary of the transmitter configuration state, the value of the BCC, once set the parameters and carried out the calibration, remains constant until the next change of parameters or calibration. A variation of the BCC value without any change occurred means that an alteration has taken place in transmitter's configuration data.

BCC calculation

The BCC messages sent by the transmitter is calculated as the XOR of all the bytes making up the message (excluding <cr> and <lf>) and divided into 2 nibble.

The two nibbles are then transformed into their ASCII codes.

The BCC transmitted at the end of record is used to check the validity of records received.

ACQUISITION

Command format: **ID + A <cr>**

Example: if ID=14 type 14A <cr> or 00A <cr>

By sending the command **A**, the transmitter responds by sending a record containing the code, the ID, date, time, and the value of all the measures.

Record format

```
C3436- 10 0.0 01/01/01 00:00:00 ± 1000uS ± 500ppm ± 20.0°C ±
.....+.....|.....+.....|.....+.....|.....+.....|.....+.....|.....+.....|.....+.....|
0.500 ± 20°C ± 2.20%/°C ± 0stat 18/11/10xx
```

C3436	p/n of the transmitter
10	ID
0.0	Power voltage (not implemented)
01/01/01	Date (not implemented)
00:00:00	Hour (not implemented)

Below are transmitted the parameter values measured by the transmitter with the following format:



Measuring	- Sign of measure (if positive is sent a blank) - Value of measure (6 characters - right alignment)
Measuring unit	- 4 characters - left alignment - 1 blank (ASCII 32)
± 1000 uS	Conductivity value
± 500 ppm	TDS value
± 20.0 °C	Temperature
± 0.500	TDS/EC conversion factor
± 20 °C	Reference temperature
± 2.20 %/°C	Temperature coefficient
± 0stat	State - bit 0 logic input: 0 = open; 1 = close - bit 1 hold from keyboard: 0 = no hold; 1 = hold - bit 2 manual temperature: 0 = auto; 1 = manual

At the end of the record the transmitter sends the last calibration date, then 2 bytes containing the BCC of the string sent.

18/11/10	Date of the last calibration
xx	2 byte BCC

The record transmission is ended by <cr> <lf>.

BCC calculation

The BCC messages sent by the transmitter is calculated as the XOR of all the bytes of the message (excluding <cr> and <lf>) and divided into two nibbles.

The two nibbles are then transformed into their ASCII codes.

CURRENT LOOP

Command format: **ID + L + x <cr>**

Example: if ID=14 and you want to enable the current loop type 14L0 <cr> or 00L0 <cr>

Response of the unit: <lf> ID + L + x <cr> <lf>	command executed correctly
Response of the unit: none	command failed

It is possible to enable or disable the current loop in the configuration menu by selecting:

x=0 current loop disabled

x=1 current loop enabled

CELL CONSTANT

Command format: **ID + K + x <cr>**

Example: if ID=14 and K cell = 1, type 14K3 <cr> or 00K3 <cr>



Response of the unit: **<lf> ID + K + x <cr> <lf>**

command executed correctly

Response of the unit: none

command failed

The K cell can be set with the following values:

x=1 K cella = 0.1

x=2 K cella = 0.5

x=3 K cella = 1.0

x=4 K cella = 10

ANALOG OUTPUT

Command format: **ID + O + x <cr>**

Example: if ID=14 and analog out = 1 scale (range 0 to 1000 mV) type 14O1 <cr> or 00O1 <cr>

Response of the unit: **<lf> ID + O + x <cr> <lf>**

command executed correctly

Response of the unit: none

command failed

The 4-20 mA analog output can be assigned to one of the five EC scales. According to the K cell selected the five scales take on a different value:

Conductivity				
	K=0.1	K=0.5	K=1.0	K=10
x=1 for scale 1	2.000 µS	10.00 µS	20.00 µS	200.0 µS
x=2 for scale 2	20.00 µS	100.0 µS	200.0 µS	2000 µS
x=3 for scale 3	200.0 µS	1000 µS	2000 µS	20.00 mS
x=4 for scale 4	2000 µS	10.00 mS	20.00 mS	200.0 mS
x=5 for scale 5	20.00 mS	100.0 mS	200.0 mS	2000 mS

TDS				
	K=0.1	K=0.5	K=1.0	K=10
x=1 for scale 1	1.000 ppm	5.00 ppm	10.00 ppm	100.0 ppm
x=2 for scale 2	10.00 ppm	50.0 ppm	100.0 ppm	1000 ppm
x=3 for scale 3	100.0 ppm	500 ppm	1000 ppm	10.00 ppt
x=4 for scale 4	1000 ppm	5.00 ppt	10.00 ppt	100.0 ppt
x=5 for scale 5	10.00 ppt	50.0 ppt	100.0 ppt	1000 ppt

SCALE FACTOR

Command format: **ID + X + x <cr>**

Example: if ID=14 and the scale factor is 50% type 14X50 <cr> or 00X50 <cr>



Response of the unit: <lf> ID + x + x <cr> <lf>	command executed correctly
Response of the unit: none	command failed

To verify the receiving of the value type **ID + H**.

Examples of scales factors selection:

Scale factor	full scale
100%	20 μ S / 200 μ S / 2000 μ S / 20 mS / 200 mS
50 %	10 μ S / 100 μ S / 1000 μ S / 10 mS / 100 mS
25 %	5 μ S / 50 μ S / 500 μ S / 5 mS / 50 mS
10 %	2 μ S / 20 μ S / 200 μ S / 2 mS / 20 mS

TDS SCALE

Command format: **ID + M + x <cr>**

Example: if ID=14 and you want to enable the TDS measurement TDS type 14M1 <cr> or 00M1 <cr>

Response of the unit: <lf> ID + M + x <cr> <lf>	command executed correctly
Response of the unit: none	command failed

It is possible to enable or disable the TDS measurement in the configuration menu by selecting:

- x=0 4-20 mA on conductivity
- x=1 4-20 mA on TDS

To check whether the entered value has been received type command **ID + H**.

TDS/EC CONVERSION FACTOR

Command format: **ID + F + x <cr>**

Example: if ID=14 and the factor TDS/EC to select is 0.550, type 14F0.550 <cr> or 00F0.550 <cr>

Response of the unit: <lf> ID + F + x <cr> <lf>	command executed correctly
Response of the unit: none	command failed

To check whether the entered value has been received type command **ID + H**.

LARGE FILTER

Command format: **ID + RL + x <cr>**

Example: if ID=14 and the response time is 5 seconds, type 14RL5 <cr> or 00RL5 <cr>

Response of the unit: <lf> ID + RL + x <cr> <lf>	command executed correctly
Response of the unit: none	command failed

To check whether the entered value has been received type command **ID + H**.



SMALL FILTER

Command format: **ID + RS + x <cr>**

Example: if ID=14 and the response time is 5 seconds type 14RS5 <cr> or 00RS5 <cr>

Response of the unit: **<lf> ID + RS + x <cr> <lf>**

command executed correctly

Response of the unit: none

command failed

To check whether the entered value has been received type command **ID + H.**\

TEMPERATURE MEASURING UNIT

Command format: **ID + W + x <cr>**

Example: if ID=14 and the unit of measurement of the temperature is °C type 14W1 <cr> or 00W1 <cr>

Response of the unit: **<lf> ID + W + x <cr> <lf>**

command executed correctly

Response of the unit: none

command failed

The temperature measuring unit can be configured with the following values:

x=1 measuring unit °C

x=2 measuring unit °F

TEMPERATURE CALIBRATION

Command format: **ID + J + x <cr>**

Example: if ID=14 and the temperature value to be taken is 23.2 °C type 14J23.2 <cr> or 00J23.2 <cr>

Response of the unit: **<lf> ID + J + x <cr> <lf>**

command executed correctly

Response of the unit: none

command failed

Zero adjustment of the temperature measure.

To verify the results of the temperature correction use the **ID + A**, the temperature reading should be approx. same as the adjusted value.

With the command **ID + H** control the line "Temp. adjust: ok / error".

With the command **ID + J?** you can read the result directly.

If the operation has failed (error) the previous zero value is retained.

The "Temp. adjust: not done" message indicates that the parameter has been restored to the default value with the command **ID + JR**.

TEMPERATURE CALIBRATION RESET

Command format: **ID + JR <cr>**

Example: if ID=14 type 14JR <cr> or 00JR <cr>



Response of the unit: **<lf> ID + JR <cr> <lf>** command executed correctly

Response of the unit: none command failed

This command allows you to return the value of the zero temperature to the default value. Verify the outcome of the operation with the command **ID+H** and check the line "Temp. adjust: not done".

TEMPERATURE CALIBRATION TEST

Command format: **ID + J? <cr>**

Example: if ID=14 type 14J? <cr> or 00J? <cr>

Response of the unit: **<8 characters outcome>** command executed correctly
<blank> <7 digit value> <4 characters unit> <cr> <lf>

Response of the unit: none command failed

Record format

```
ok      ±  0.2°C
.....+.....|.....+.....|.....+.....|.....+.....|.....+.....|.....+.....|.....+.....|
```

The possible results are: ok / not done / error.

MANUAL TEMPERATURE

Command format: **ID + N + x <cr>**

Example: if ID=14 and the manual temperature is 28.3 °C type 14N28.3 <cr> or 00N28.3 <cr>

Response of the unit: **<lf> ID + N + x <cr> <lf>** command executed correctly

Response of the unit: none command failed

To check whether the entered value has been received type command **ID + H**.

REFERENCE TEMPERATURE

Command format: **ID + G + x <cr>**

Example: if ID=14 and the reference temperature is 25 °C, type 14G2 <cr> or 00G2 <cr>

Response of the unit: **<lf> ID + G + x <cr> <lf>** command executed correctly

Response of the unit: none command failed

The reference temperature can be selected as follows;

x=1 TRef=20 °C

x=2 TRef=25 °C

To check whether the entered value has been received type command **ID + H**.



TEMPERATURE COEFFICIENT

Command format: **ID + C + x <cr>**

Example: if ID=14 and the TC is 2.10 %/°C type 14C2.10 <cr> or 00C2.10 <cr>

Response of the unit: **<lf> ID + C + x <cr> <lf>** command executed correctly

Response of the unit: none command failed

To check whether the entered value has been received type command **ID + H**.

TEMPORARY MEASUREMENT WITH KCL TC

Command format: **ID + V + x <cr>**

Example: if ID=14 and you need to measure using KCl TC type 14V1 <cr> or 00V1 <cr>

Response of the unit: **<lf> ID + V + x <cr> <lf>** command executed correctly

Response of the unit: none command failed

The command allows to calibrate the sensitivity (using the command **ID + S <cr>**) with a standard KCl solution in order to read the conductivity value before and after calibration by applying the TC of the KCl and not the one set.

To check whether the entered value has been received type command **ID + H?** or **ID + H**.

Once the sensitivity calibration is completed, the TC of the KCl will be maintained for the next 20 seconds to allow verification of the correct calibration carried out with the KCl standard.

After 20 seconds the TC will be automatically reset to the set use TC.

Also the reset sensitivity operation resets to the use CT after the expected 20 seconds.

If the request to measure with the TC of the KCl is activated and within 30 minutes the sensitivity calibration is not performed, the TC is automatically returned to the user TC.

To instantly go back to measuring with the TC setting you need to perform the sensitivity calibration type 14V0 <cr> or 00V0 <cr>.

STANDARD SOLUTION

Command format: **ID + T + x <cr>**

Example: if ID=14 and the standard solution value is 1413 μS type 14T1413 <cr> or 00T1413 <cr>

Response of the unit: **<lf> ID + T + x <cr> <lf>** command executed correctly

Response of the unit: none command failed

To check whether the entered value has been received type command **ID + H**.

STANDARD SOLUTION MEASURING UNIT

Command format: **ID + U + x <cr>**

Example: if ID=14 and the standard solution measuring unit is μS type 14U1 <cr> or 00U1 <cr>

Response of the unit: **<lf> ID + U + x <cr> <lf>** command executed correctly

Response of the unit: none command failed



The unit of measure of the standard solution can be set with the following values:

x=1 μS

x=2 mS

To check whether the entered value has been received type command **ID + H**.

ZERO CALIBRATION

The zero calibration must be done with the dry cell connected to the transmitter.

The transmitter resets the value of the conductivity on all 5 scales automatically starting from the lower scale.

The zero calibration is to be carried out preferably at the first installation before calibration the sensitivity.

Command format: **ID + Z <cr>**

Example: if ID=14 type 14Z <cr> or 00Z <cr>

Response of the unit: **<lf> ID + Z <cr> <lf>**

command executed correctly

Response of the unit: none

command failed

To verify the results of the zero calibration use the **ID + A**; the conductivity reading should be around 0 $\mu\text{S}/\text{mS}$.

With the command **ID + H** control the line "Zero calibration: ok / error".

With the command **ID + Z ?** you can read the result directly.

If the operation has failed (error), the previous zero value is retained.

Check if the cell is perfectly clean and dry.

The message "Zero calibration: not done" indicates that the parameter has been restored to the default value with the command **ID + ZR**.

ZERO CALIBRATION RESET

Command format: **ID + ZR <cr>**

Example: if ID=14 type 14ZR <cr> or 00ZR <cr>

Response of the unit: **<lf> ID + ZR <cr> <lf>**

command executed correctly

Response of the unit: none

command failed

This command allows you to restore the zero value to the default values.

Verify the outcome of the operation with the **ID + H** and check the line "Zero calibration: not done".

ZERO CALIBRATION TEST

Command format: **ID + Z? <cr>**

Example: if ID=14 type 14Z? <cr> or 00Z? <cr>



Response of the unit:	<8 characters outcome> <blank> <7 digit value> <4 characters unit> <cr> <lf>	command executed correctly
Response of the unit:	none	command failed

Record format

```

ok      ±      10uS
.....+.....|.....+.....|.....+.....|.....+.....|.....+.....|.....+.....|.....+.....|
    
```

Possible results: ok / not done / error.

SENSITIVITY CALIBRATION

The sensitivity calibration is done in a standard solution or in solution in known conductivity.

The value of the standard solution should be inserted through the commands "Set standard solution" and "Set standard measure unit".

The TC (temperature coefficient) used by the unit during the calibration is the one setted if parameter V is 0 or that of KCl if parameter V is 1.



Once the sensitivity calibration is complete, the TC of the KCl will be maintained for the next 20 seconds to allow verification of the correct calibration carried out with the KCl standard.

After 20 seconds the TC will be automatically returned to the setted TC.

The calibration is performed on the selected scale and the new sensitivity value will also be applied to the other scales.

Command format: **ID + S <cr>**

Example: if ID=14 type 14S <cr> or 00S <cr>

Response of the unit:	<lf> ID + S <cr> <lf>	Command executed correctly
Response of the unit:	none	Command failed

To verify the results of the calibration, use the **ID + A**; the conductivity reading should be about the value of the calibration solution (if the TC in use is identical to that of the KCl used in the calibration).

Through the command **ID + H** the user controls the line "Sens. calibration: ok / error". Through the command **ID + S?** the user can read the result directly.

If the calibration has failed (error) check that the conductivity cell is properly immersed in the standard solution.

Inspect the state of the surfaces of the measuring cell, if necessary, clean the surfaces with a soft cloth.

In case of failure the transmitter resets its previous sensitivity.

The message "Sens. calibration: not done" indicates that the parameter has been restored to the default value through the command **ID + SR**.



SENSITIVITY CALIBRATION RESET

Command format: **ID + SR <cr>**

Example: if ID=14 type 14SR <cr> or 00SR <cr>

Response of the unit: **<lf> ID + SR <cr> <lf>** command executed correctly

Response of the unit: none command failed

This command allows to return to the default sensitivity value of 100.0 %.

Verify the outcome of the operation through the command **ID + H** and check the line "Sens. calibration: not done".

SENSITIVITY CALIBRATION TEST

Command format: **ID + S? <cr>**

Example: if ID=14 type 14S? <cr> or 00S? <cr>

Response of the unit: **<8 characters outcome>** command executed correctly
<blank> <7 digit value> <4 characters unit> <cr> <lf>

Response of the unit: none command failed

Record format

```
ok      ± 100.0%
.....+.....|.....+.....|.....+.....|.....+.....|.....+.....|.....+.....|.....+.....|
```

Possible results: ok / not done / error.

LAST CALIBRATION DATE

Command format: **ID + D + XX/XX/XX <cr>** (XX = 00 ÷ 99)

Example: if ID=14 and the date to be inserted is 11/05/18 type 14D11/05/18 <cr> or 00D11/05/18 <cr>

Response of the unit: **<cr> <lf> ID + D + XX/XX/XX <cr> <lf>** command executed correctly

Response of the unit: none command failed

This command allows to store the last calibration date.

The date field is 8 characters to be written in the proposed format.

ID OF THE B&C PROTOCOL

Command format: **ID + I + x <cr>**

Example: if ID=14 and the new ID (identification) to enter is 07 type 14I07 <cr> or 00I07 <cr>

Response of the unit: **<lf> ID + I + x <cr> <lf>** command executed correctly

Response of the unit: none command failed

The transmitter activates the new ID immediately after the response to the command.



ID OF THE MODBUS PROTOCOL

Command format: **ID + E + x <cr>**

Example: if ID=14 and the new ID (identification) to enter is 07 type 14E07 <cr> or 00E07 <cr>

Response of the unit: **<lf> ID + E + x <cr> <lf>** command executed correctly

Response of the unit: none command failed

The transmitter activates the new ID immediately after the response to the command.

BAUD RATE

Command format: **ID + B + x <cr>**

Example: if ID=14 and the new speed is 2 = 4800 baud type 14B2 <cr> or 00B2 <cr>

Response of the unit: **<lf> ID + B + x <cr> <lf>** command executed correctly

Response of the unit: none command failed

Set the parameter:

- x=1 for 2400 baud
- x=2 for 4800 baud
- x=3 for 9600 baud
- x=4 for 19200 baud

The transmitter activates the new ID immediately after the response to the command.

COMMANDS USING ID + SNxxxxxx

From release R3.00 it has been added the possibility to query the transmitters by inserting the serial number of the transmitter in addition to the ID for **all the commands provided**.

Example: the command to acquire the measurement of a transmitter with ID=14 and SN123456 can be performed with:

interrogation using ID 14A <cr> or 00A <cr>

interrogation using ID+SNxxxxxx 14SN123456A <cr> or 00SN123456A <cr>

The interrogation with ID + SNxxxxxx becomes a unique command thus allowing to be able to insert more than 99 devices on the network, limit imposed by the commands with ID.

A command is also provided with serial number broadcast ID + SN000000 to which all the transmitters respond.

SEARCH TRANSMITTER TYPE, ID AND SERIAL NUMBER

Command format: **ID + SN? <cr>**



Example: if the ID is known (ID=14) type 14SN? <cr> to know code and serial number or type 00SN? <cr> to search all the transmitters in the network.

Response of the unit:	<6 characters code> <2 characters ID> <6 characters serial number> <2 characters BCC> <cr> <lf>	command executed correctly
Response of the unit:	none	command failed

```
C3436,14,123456,xx
....+. ....|. ....+. ....|
```

This command allows to search all the transmitters in a network.

The transmitters respond by providing their identity: code, ID, serial number.

The transmitter response occurs after a random time chosen by the transmitter itself between 8 time intervals: 0 ms, 200 ms, 400 ms, 600 ms, 800 ms, 1000 ms, 1200 ms, 1400 ms to avoid as much as possible an overlap of the answers when there are more transmitters on the network.

If there are more transmitters, some overlap of communication will be unavoidable.

The master device must manage the transmitters search by disabling the commands of the transmitters it has found, repeating the search command several times until it has found all the transmitters in the network.

At this point the master can re-enable the commands of the transmitters he has found.

To disable and re-enable the transmitter commands, see the command **ID + SNxxxxxx + MUx <cr>**.

The automatic management of transmitters is implemented in the MC 6587 and MC 7687 instruments of the Nieuwkoop/B&C.

DISABLE/ENABLE COMMANDS USING ID

Command format: **ID + SNxxxxxx + MUx <cr>**

Example: to disable commands using ID of a transmitter with ID=14 and serial number 123456 type 14SN123456MU1 <cr> or 00SN123456MU1 <cr>

Response of the unit:	<cr> <lf> ID + SNxxxxxx + MUx <cr> <lf>	command executed correctly
Response of the unit:	none	command failed

Set parameter:

x=0 to enable commands using ID

x=1 to disable the commands using ID

When the transmitter is disabled to commands using ID:

- can only execute commands with **ID + SNxxxxxx**;
- does not run the transmitter search command **ID + SN?**.



6.9.2 MODBUS PROTOCOL

On the transmitter, in addition to the ASCII B&C protocol, is implemented the Modbus RTU protocol limited to the function 03, 06 and 16.

In Modbus communication network the transmitter operates as a slave device. RTU

transmission mode

Coding system	8-bit binary
Number of bits per character:	
- start bits	1
- data bits (minus sign before)	8
- parity	no parity
- stop bits	1
Errors verification	CRC-16

RTU messages format

Pause transmission	duration 3,5 bytes
Address	1 byte (8 bits)
Function	1 byte (8 bits)
Data	N bytes (N x 8 bits)
Errors verification	2 bytes (16 bits)
Pause transmission	duration 3,5 bytes

For a correct synchronization of the transmission the receiving unit interprets the end of a message when it doesn't receive any characters (bytes) for a time equivalent to the transmission of 3.5 characters (bytes).



MODBUS FUNCTION 03 (0x03)

Function 03 (MASTER QUERY)

Address	1 byte	1 ÷ 243 (transmitter ID)
Function	1 byte	03 (read holding register)
Start address data HI	1 byte	Start address of registers
Start address data LO	1 byte	
Number of registers HI	1 byte	Number of registers (2 byte x register)
Number of registers LO	1 byte	
Errors verification	2 bytes	CRC-16

The transmitter considers valid the message if CRC-16 valid, ID valid and function=03.

Function 03 (SLAVE ANSWER)

Address	1 byte	1 ÷ 243 (transmitter ID)
Function	1 byte	03 (read holding register)
Number of byte of sent data	1 byte	2x number of sent registers
N byte of data	N byte	Values of registers
Error verification	2 bytes	CRC-16

If you query requesting registers outside the defined limits, the transmitter answers assigning zero to all of the registers out of range.

If an error occurs in the request, the response takes the following form:

Address	1 byte	1 ÷ 243 (transmitter ID)
Function	1 byte	0x83 (read holding register + error)
Error	1 byte	2 = illegal data address 3 = illegal data value
Error verification	2 bytes	CRC-16

Time between the end of the query and the beginning of the response about 100 ms.



MODBUS FUNCTION 06 (0x03)

Function 06 (MASTER QUERY)

Address	1 byte	1 ÷ 243 (transmitter ID)
Function	1 byte	06 (write single register)
Address data HI	1 byte	Address of registers
Address data LO	1 byte	
Value of the register HI	1 byte	Value to be written
Value of the register LO	1 byte	
Errors verification	2 bytes	CRC-16

The transmitter considers valid the message if CRC-16 valid, ID valid and function=06.

Function 06 (SLAVE ANSWER)

Address	1 byte	1 ÷ 243 (transmitter ID)
Function	1 byte	06 (write single register)
Address data HI	1 byte	Address of the register
Address data LO	1 byte	
Value of the register HI	1 byte	Value to be written
Value of the register LO	1 byte	
Error verification	2 bytes	CRC-16

When writing some calibration commands (eg. zero calibration), the transmitter responds to the request and then remains silent for the time necessary to perform the operation.

If an error occurs in the request, the response takes the following form:

Address	1 byte	1 ÷ 243 (transmitter ID)
Function	1 byte	0x86 (write single register + error)
Error	1 byte	2 = illegal data address 4 = slave device failure
Error verification	2 bytes	CRC-16

Time between the end of the query and the beginning of the response about 100 ms.



MODBUS FUNCTION 16 (0x10)

Function 16 (MASTER QUERY)

Address	1 byte	1 ÷ 243 (transmitter ID)
Function	1 byte	16 (write multiple registers)
Start address data HI	1 byte	Start address of registers
Start address data LO	1 byte	
Number of registers HI	1 byte	Number of registers (2 byte x register)
Number of registers LO	1 byte	
Number of byte	1 byte	2 byte per register
Value of registers	n byte	n = 2 byte x number of registers
Errors verification	2 bytes	CRC-16

The transmitter considers valid the message if CRC-16 valid, ID valid and function=16.

Function 16 (SLAVE ANSWER)

Address	1 byte	1 ÷ 243 (transmitter ID)
Function	1 byte	16 (write single register)
Start address data HI	1 byte	Start address of registers
Start address data LO	1 byte	
Number of registers HI	1 byte	Number of registers (2 byte x register)
Number of registers LO	1 byte	
Error verification	2 bytes	CRC-16

When writing some calibration commands (eg. zero calibration), the transmitter responds to the request and then remains silent for the time necessary to perform the operation.

If an error occurs in the request, the response takes the following form:

Address	1 byte	1 ÷ 243 (transmitter ID)
Function	1 byte	0x90 (write multiple registers + error)
Error	1 byte	2 = illegal data address 3 = illegal data value 4 = slave device failure
Error verification	2 bytes	CRC-16

Time between the end of the query and the beginning of the response about 100 ms.

BROADCAST COMMANDS

Modbus 06 and 16 queries can be made by the master in broadcast mode.

The broadcast mode consists in sending the message with the identifier 0, all the transmitters perceive the message and execute the command but do not respond to the master in order not to create conflicts.



MODBUS REGISTERS

MEASURE AND STATE (address 0x00xx)

	Modbus address	Parameter	Range	Unit	Scale	Data type	R/W
1	0x0000	Conductivity	-100 ÷ 2100	a	a	IS	R
2	0x0001	TDS	-50 ÷ 1050	a	a	IS	R
3	0x0002	Temperature °C	-100 ÷ 1100	0.1	-10.0 ÷ 110.0 °C	IS	R
4	0x0003	Temperature °F	140 ÷ 2300	0.1	14.0 ÷ 230.0 °F	IS	R
5	0x0004	K cell	1/5/10/100	b		IS	R
6	0x0005	Scale	1 ÷ 5	b		IS	R
7	0x0006	TDS/EC factor	450 ÷ 1000	0.001	0.450 ÷ 1.000	IS	R
8	0x0007	Reference temperature	25 / 20	°C	20 °C / 25 °C	IS	R
9	0x0008	Temperature coefficient	0 ÷ 350	0.01	0.01 ÷ 3.50 %/°C	IS	R
10	0x0009	State: Dig. Inp. Keyb. lock Man. temp.	0/1 0/1 0/1	1 bit0 bit1 bit2	open/close no hold/hold auto/man	I	R
11	0x000A	BCC EEPROM	0 ÷ 65535	1	0 ÷ 65535	I	R

^a = unit and scale depend on what is set in configuration (see 5 and 6)

^b = see chapter "Configuration (page 31)"

IS = integer signed / I = integer

R = read / W = write



ZERO CALIBRATION (address 0x010x)

	Modbus address	Parameter	Range	Unit	Scale	Data type	R/W
12	0x0102	Zero command/flag - zero cal - reset zero - flag zero cal	0x5A00 0x5A52 0 = not done 1 = ok 2 = error	1 1 1		IS	W W R
13	0x0103	Zero value	-200 ÷ 200	a	a	IS	R

^a = unit and scale depend on what is set in configuration (see 5 and 6)

IS = integer signed / I = integer

R = read / W = write

	Modbus address	Parameter	Range	Unit	Scale	Data type	R/W
14	0x0110	Meas. with KCI TC	0 ÷ 1	1	0 = no 1 = yes	IS	R/W
15	0x0111	Std. measure unit	1 ÷ 2	1	1 = μ S 2 = mS	IS	R/W
16	0x0112	Decimal point standard sens.	0 ÷ 3	1		IS	R/W
17	0x0113	Standard sens - decimal point=0 - decimal point=1 - decimal point=2 - decimal point=3	0 ÷ 2000 0 ÷ 2000 0 ÷ 2000 0 ÷ 2000	1 0.1 0.01 0.001	μ S / mS 0 ÷ 2000 0.0 ÷ 200.0 0.00 ÷ 20.00 0.000 ÷ 2.000	IS	R/W
18	0x0114	Sens command/flag - sens cal - reset sens - flag sens cal	0x5300 0x5352 0 = not done 1 = ok 2 = error	1 1 1		IS	W W R
19	0x0115	Sens value	600 ÷ 1600	0.1	60.0 ÷ 160 %	IS	R

IS = integer signed / I = integer

R = read / W = write



TEMPERATURE CALIBRATION (address 0x012x)

	Modbus address	Parameter	Range	Unit	Scale	Data type	R/W
20	0x0120	Temp command/flag - reset temp - flag temp cal	0x4A52 0 = not done 1 = ok 2 = error	1 1		IS	W R
21	0x0121	Temp. adj	-100 ÷ 1100 -140 ÷ 2300 -50 ÷ 50 -90 ÷ 90	0.1 0.1 0.1 0.1	-10.0 ÷ 110.0 °C -14.0 ÷ 230.0 °F -5.0 ÷ 5.0 °C -9.0 ÷ 9.0 °F	IS	W R

IS = integer signed / I = integer

R = read / W = write

SETUP (address 0x020x)

	Modbus address	Parameter	Range	Unit	Scale	Data type	R/W
22	0x0200	Large filter	1 ÷ 20	1	1 ÷ 20 s	IS	R/W
23	0x0201	Small filter	1 ÷ 20	1	1 ÷ 20 s	IS	R/W

IS = integer signed / I = integer

R = read / W = write

	Modbus address	Parameter	Range	Unit	Scale	Data type	R/W
24	0x0210	Temp unit	1 ÷ 2	1	1 = °C 2 = °F	IS	R/W
25	0x0211	Temp man	0 ÷ 1000 320 ÷ 2120	0.1	0.0 ÷ 100.0 °C 32 ÷ 212.0 °F	IS	R/W
26	0x0212	Coeff. temp.	0 ÷ 350	0.01	0.01 ÷ 3.50 %/°C	IS	R/W
27	0x0213	Temp ref	20 / 25		20 °C / 25 °C	IS	R/W

IS = integer signed / I = integer

R = read / W = write



CONFIGURATION (address 0x030x)

	Modbus address	Parameter	Range	Unit	Scale	Data type	R/W
28	0x0300	Current loop	0 ÷ 1	1	0 = disable 1 = enable	IS	R/W
29	0x0301	Scale	1 ÷ 3	1	α	IS	R/W
30	0x0302	Full scale scalability	10 ÷ 100	1	10 ÷ 100 %	IS	R/W
31	0x0303	Baud rate	1 ÷ 4	1	1 = 2400 2 = 4800 3 = 9600 4 = 19200	IS	R/W
32	0x0304	ID B&C	1 ÷ 99	1		IS	R/W
33	0x0305	ID Modbus RTU	1 ÷ 243	1		IS	R/W

α = see chapter "Configuration (page 31)"

IS = integer signed / I = integer

R = read / W = write

C3436 CONFIGURATION (address 0x030x)

	Modbus address	Parameter	Range	Unit	Scale	Data type	R/W
34	0x0310	TDS on/off	0 ÷ 1	1	0 = OFF 1 = ON	IS	R/W
35	0x0311	TDS factor	450 ÷ 1000	0.001	0.450 ÷ 1.000	IS	R/W
36	0x0312	K cell	1/5/10/100	0.1	0.1/0.5/1.0/10	IS	R/W

IS = integer signed / I = integer

R = read / W = write



INFO TRANSMITTER (address 0x040x)

	Modbus address	Parameter	Range	Unit	Scale	Data type	R/W
37	0x0401	Code	6 characters			I	R
38	0x0404	Serial number	6 characters			I	R
39	0x0407	Rev. fw	4 characters			I	R
40	0x0409	Last cal date (1)	00 ÷ 99	1		IS	R/W
41	0x040A	Last cal date (2)	00 ÷ 99	1		IS	R/W
42	0x040B	Last cal date (3)	00 ÷ 99	1		IS	R/W

IS = integer signed / I = integer

R = read / W = write

Use of BCC EEPROM

The EEPROM BCC check is the transmitter configuration state synthesis. After setting the parameters and carry out the calibration the value of the BCC remains constant until the next change of parameters or calibration.

A variation of BCC in the absence of changes warns that an alteration has taken place in the transmitter configuration data.

7 INSTALLATION DRAWINGS

7.1 CONNECTIONS

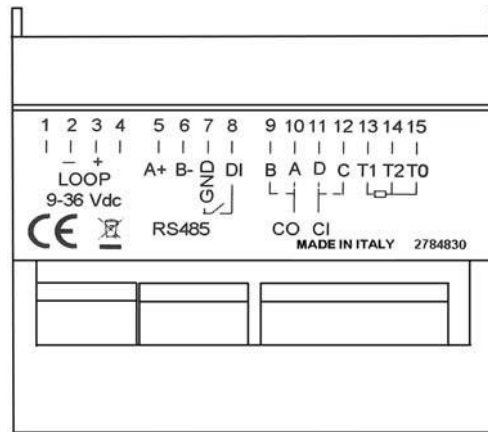

Terminal	Function
2	- Loop
3	+ Loop (9 ÷ 36 Vdc)
5	RS485 A+
6	RS485 B-
7	RS485 Gnd
7	Digital input
8	Digital input
9	Voltage electrode input
10	Current electrode input
11	Current electrode input
12	Voltage electrode input
13	Temperature sensor input
14	Common temperature sensor input
15	Common temperature sensor input



7.2 DIMENSIONS

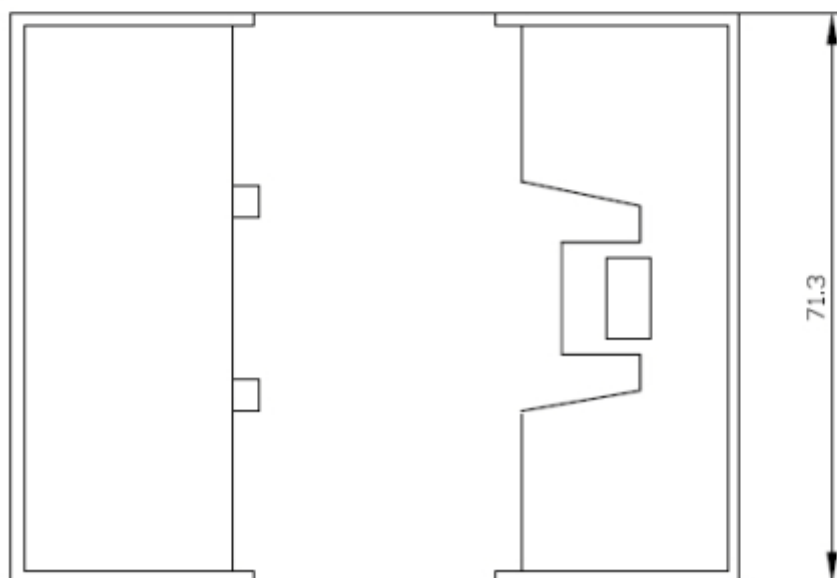
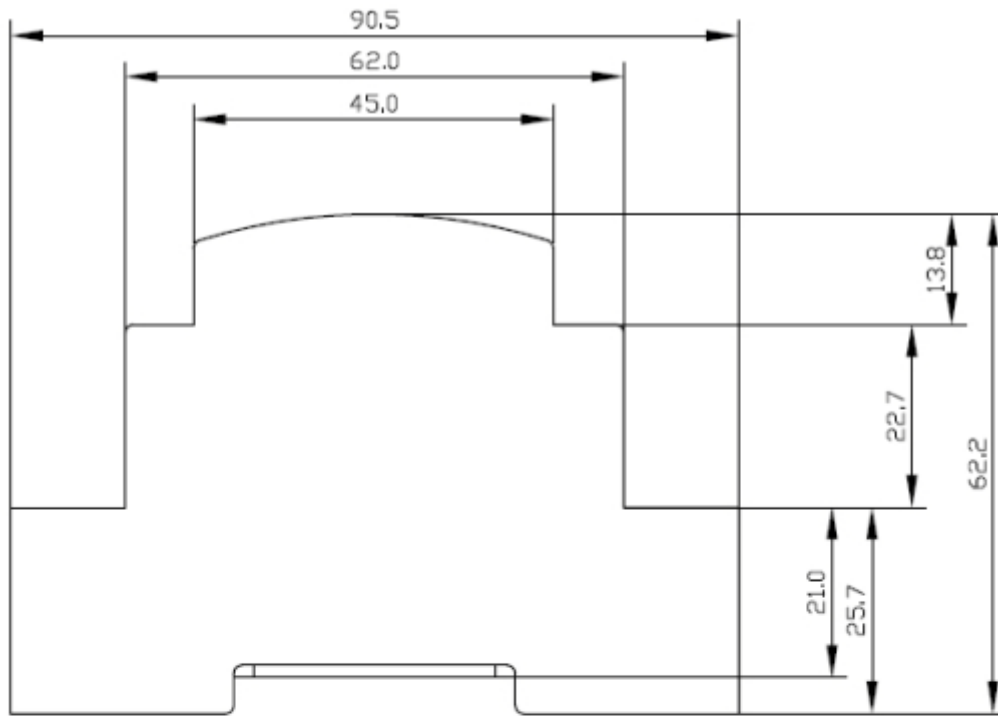

7.3 ANALOG MODE WIRING

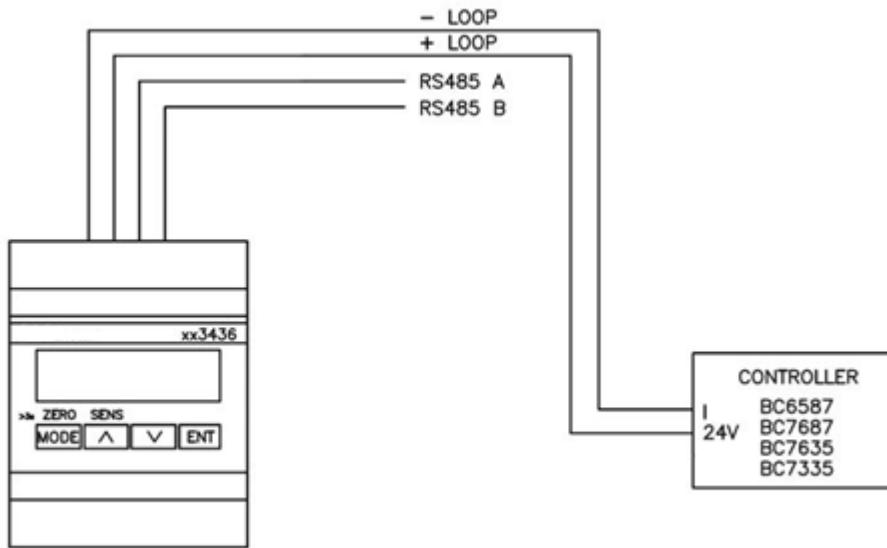

Connection to Nieuwkoop B.V/B&C instruments

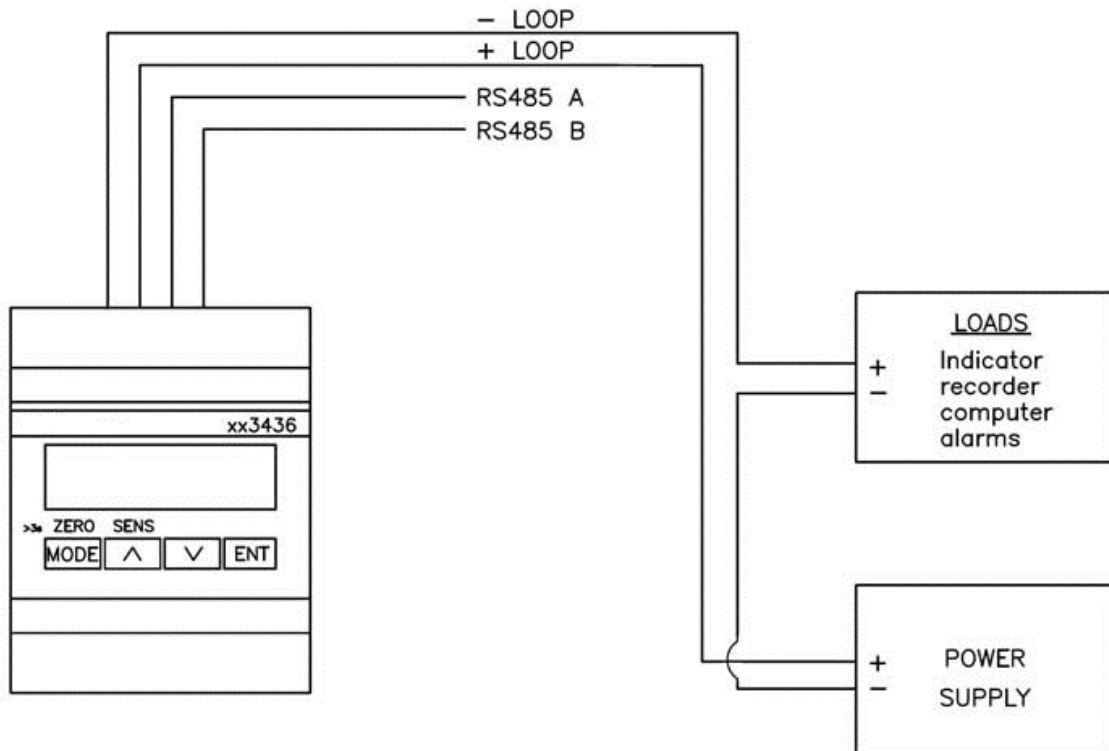

Connection to PLC or data logger



7.4 DIGITAL MODE WIRING

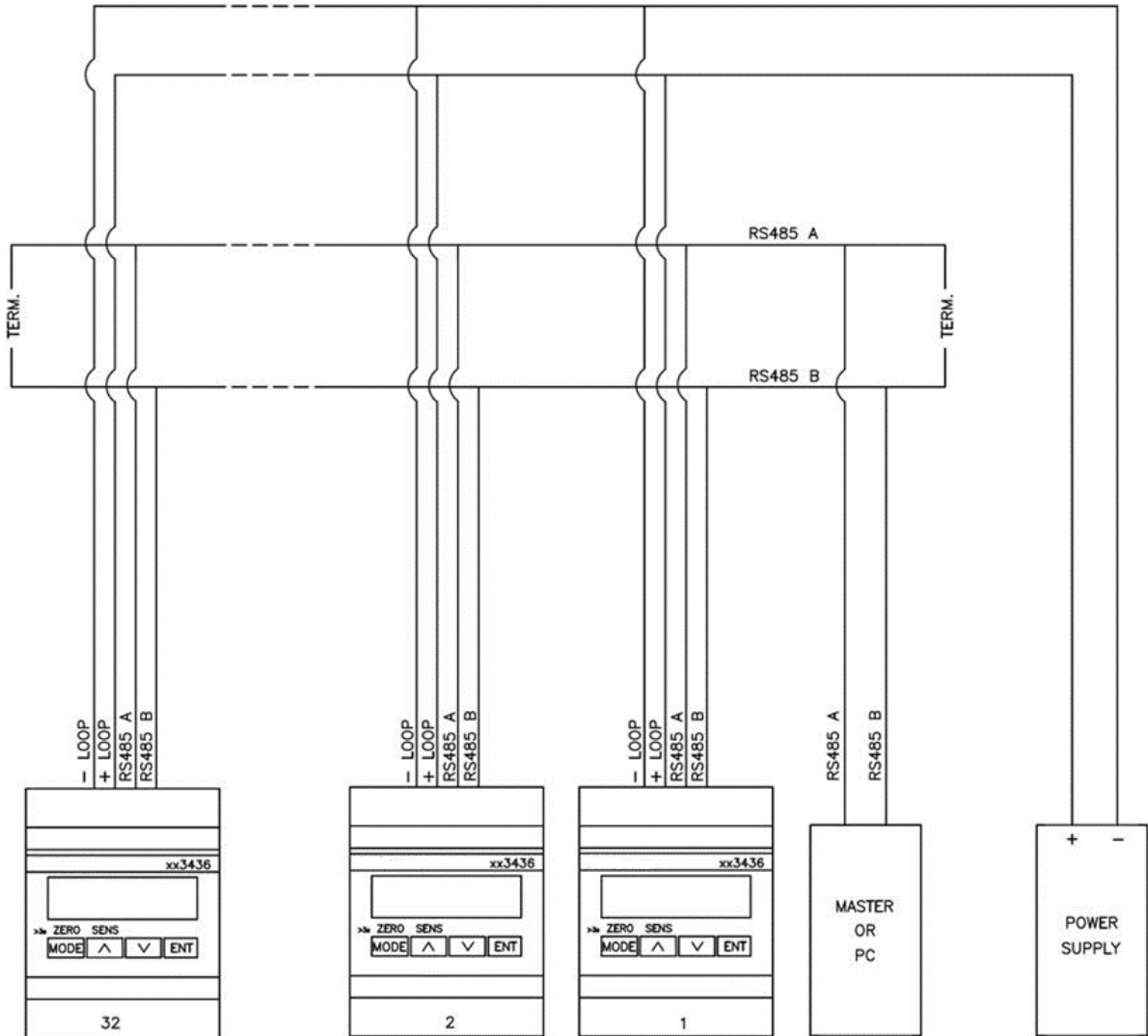



8 WARRANTY

- 1 Your product is guaranteed for 5 years from the date of purchase, for failure due to manufacturing defects.
 - 2 The warranty is void in case of tampering or deterioration due to improper installation or maintenance.
 - 3 The warranty covers only free repair at the laboratories of the manufacturer.
 - 4 Nieuwkoop B.V./B&C is not liable for any damage arising from misusing its instruments and products.
-

9 REPAIRS

For faster and efficient service it is recommended to fill in the "Information card" for the repair service and attach it to a "Repair order".

- 1 The estimated cost, if required by the customer, is free if the repair is confirmed. Otherwise flat rate results in a charge for the analytical work performed and expenses incurred.
- 2 The products to be repaired must be sent to Nieuwkoop B.V./B&C with freight prepaid. Any expenses incurred on behalf of the client and not previously agreed will be charged.
- 3 Our sales department will submit to the customer the repair estimate or offer a replacement in the following cases:
 - repair cost is considered excessive in relation to the cost of the product;
 - the repair is technically impossible or unreliable.
- 4 In order to reduce the time of delivery of the repaired products, unless otherwise offered or arranged by the customer, the shipment will be made with ex-factory, prepaid carriage by a courier.



INFORMATION SHEET
for service repairs

In the event of a fault, we recommend you contact our repair service, to photocopy and complete this information sheet to be attached to the product to be repaired.

ESTIMATE

REPAIR

COMPANY NAME

ADDRESS

ZIP

TOWN

REFER TO MR/MRS

TELEPHONE

MODEL

S/N

DATE

Consult the instruction manual to identify the area of the defect and/or describe it:

SENSOR

ANALOG OUTPT

POWER SUPPLY

SET POINT

CALIBRATION

RELAYS CONTACTS

DISPLAY

INTERMITTENT PROBLEM

DESCRIPTION OF THE DEFECT

.....

.....

.....

.....

.....

.....

.....



TO MEASURE  TO KNOW

Nieuwkoop BV

Aalsmeerderweg 249 -S

1432 CM AALSMEER

0297 325836

info@nieuwkoopbv.nl

www.meten.nl



NIEUWKOOP