



NIEUWKOOP

USER MANUAL



CB1030

NITRATE METER



TO MEASURE  TO KNOW



CONTENTS

1.	Introduction.....	3
2.	Operating controls and battery.....	3
3.	Memory function.....	5
4.	Clock and calendar functions.....	6
5.	Maximising performance.....	7
6.	Taking a reading.....	9
7.	Care and maintenance.....	11



1. Introduction

The CB1030 offers a simple and speedy means for the quantitative assessment of the nitrate content of water, soil or plant samples, in conjunction with **Mquant** Nitrate test strips (other test strips should *not* be used).

The CB1030 incorporates a 20-reading memory, stored readings automatically being 'tagged' with day/date information from the meter's integral clock/calendar. Optionally, a range of calibrations can also be selected by means of a 'Lot number' feature, providing some degree of compensation for test strip batch variation.

The CB1030 has a measurement range of **5-500 ppm** (mg/l) nitrate: for measuring higher nitrate concentrations (e.g. in plant sap), the sample must first be diluted – see section 5.6.

As with any measurement process, accuracy and repeatability depend not only on the adequacy of the equipment and materials used, but also on care and precision both in the preparations of samples to be tested and in the operational technique itself.

It is therefore recommended that these operating instructions are read carefully before use, and that some practice measurements are carried out to gain familiarity with the system before attempting any 'real' assessments.

The CB1030 is supplied complete with:

- A handy, protective carrying case
- A plastic "checker" strip for testing the meter's calibration (see section 7.2)
- A small brush for cleaning the meter's optical system (see section 7.1)
- A user manual
- Nitrate test (CB2100)
- Battery

2. Operating controls and battery

The read-head and test strip carrier:

The black section at one end of the meter is the read-head, incorporating the hatch and into which fits the test strip carrier, which is removable so that both it and the read-head can be cleaned occasionally (see page 11-12).

The hatch:

The hinged door fitted to the read-head is the main operating control; as well as allowing insertion and removal of test strips, opening the hatch switches the meter on at the start of a test, and subsequent opening and closing continues the measurement process.



The push-buttons:

These function controls are only used for setting and adjusting Lot numbers (see section 5.5), setting and adjusting the meter's integral clock/calendar (see section 4), and reviewing the meter's memory content (see section 3).

● Circular push-button

■ Square push-button

▲▼ Triangular push-buttons.

These two are used to: - increase or reduce a displayed number (holding either down for a second or two will cause the number concerned to 'roll' until the button is released)
- 'search' through the meter's memory

The alarm switch:

The meter's 'beeper' can be switched off by sliding this switch (on the side of the meter, near the printed name) towards the battery compartment end of the meter (though, since the beeper's warning is often useful, it should normally be left switched on).

The battery:

The meter operates from a single 9V battery with a twin press-stud connector. Battery life depends very much on the type of battery being used and on the pattern of use. However, up to 500 or more readings can be expected when using a 'standard' battery, and substantially more when using a 'high-power' (MnAl) type.

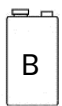

In the right-hand corner of the display will indicate when the battery is near the end of its useful life. The meter will still function properly (and will retain its memory content), but early replacement is advisable.



shown in the main display area when the meter is switched on indicates that the battery is too flat to run the meter properly, and must be replaced. Testing cannot proceed.

To fit a battery:

Note: Provided the meter is switched off, it will retain its memory content, including day/date and Lot number information, for up to about 30 seconds when the battery is disconnected. A longer disconnection period, or any disconnection at all while the meter is switched on, will cause all such stored data to be lost.









- Remove the battery cover by pulling it away from the end of the meter, disconnect and remove the old battery if applicable, insert the new battery, and attach the connector, ensuring it is connected firmly and the right way round.
- Replace the battery cover, taking care not to 'trap' the battery leads in the process.

The battery should be removed altogether during any prolonged period of non-use (of several months or more) to minimise the risk of damage from possible battery leakage – first ensure that any 'memory' readings have been noted.

3. Memory function

The most recent 20 readings are automatically stored in memory, complete with date/time from the meter's clock/calendar, for later review as required. Each new reading after the first 20 automatically overwrites the oldest previously stored reading.

To review the memory contents:









- Open the hatch and wait for **CAL**
- Press  : the display will show **Clr** if the memory is empty, otherwise it will show:
The most recently stored results, e.g.: **47 ppm**, and
The **day** and **time** when it was stored, e.g.: **TH 9:37 PM**, and
M to indicate a 'memory' reading
- To review other stored readings, press  
Repeated pressing of the "up" button accesses the "next newest" reading; repeated pressing of the "down" button the "next oldest" reading. The meter beeps to indicate when a search in either direction can go no further.
- To review the **date** of any displayed, stored, reading, press , and the date (YY-MM-DD) will be shown together with the "reading number" – from **#0** for the most recently stored reading, through to **#19** for the oldest stored reading.
- With the **date** and "reading number" displayed, each stored reading can be reviewed in succession by pressing the "up" and "down" buttons.
To display the **date** and **time** of any given stored reading, press .
Press  again to revert to **date** and "reading number".
- Close the hatch to switch the meter off.







4. Clock and calendar functions

The internal clock/calendar enables stored readings to be automatically 'tagged' with the time and date when they were taken.

Adjusting the date

- Open the hatch and wait for **CAL**
- Press  twice: **Cloc** is displayed
- Press , then press  : the **year** display will start to flash
- Press  until the correct year is displayed
- Press  again: the **date** display will start to flash
- Press  until the correct date is displayed (the meter automatically calculates the day of the week)
- Press  to complete the procedure, **or** press  again to adjust the time (the **time** display will flash, see below).
- Close the hatch to switch the meter off.

Adjusting the time:

- Open the hatch and wait for **CAL**
- Press  twice: **Cloc** is displayed
- Press  : the **time** display will start to flash.
- Press  to set the time not more than one minute ahead of the correct time
- Press  as soon as the correct time has 'caught up' with the displayed time
- Close the hatch to switch the meter off.

Note: It is best to adjust the time *after* adjusting the date, because the meter's clock 'stops' during such adjustments, and may therefore be 'slow' after any prolonged date adjustment.

The meter's internal calendar runs to 31st December 2025. For use after this date, an earlier year, with matching leap-year and day-of-week/date characteristics, should be selected, and the year 'translated' during memory review.



5. Maximising performance

The accuracy of the meter depends not only on the performance of the meter itself, but also on the consistent characteristics, correct handling, and storage of the test strips, and on the correct and careful preparation and application of the samples to be measured. The following sections highlight some ways to minimize potential errors from these various sources.

5.1 General

Ensure that all materials required are in place before starting any measurement process. Consistent timing and technique are both necessary for best results, and neither are easily achievable unless every item comes readily to hand, where and when required.

5.2 Multiple readings

For maximum confidence in the result from a single sample, especially when significant action may be taken based on that result, it is recommended that three separate readings (using three separate test strips) are taken of each sample, with the average of the three results (assuming no one result is substantially different from the other two) being taken as the definitive value.

5.3 Sample application

Instead of dipping the test strip into the sample solution to be measured, and then vigorously shaking the test strip as described in section 6, an alternative technique for improved accuracy is to apply a measured volume of liquid to the test strip pad, by means of a micro-pipetter or syringe. A sample volume of approximately 7.5 microlitres is recommended for exactly covering the test strip pad, and obviating the need to shake surplus liquid off the test strip before measurement.

5.4 Test strip variation

By the nature of the manufacturing process, there can be slight variation in all test strips' performance, both from one to another within a single batch (usually small), and from one batch to another (sometimes more significant).

Effects of the former variation can be minimized by the multiple-sampling approach outlined above.

To minimize the effect of any batch-to-batch variation, it is recommended (at least for critical applications) that each new batch of test strips is characterized before "live" use by means of a standard nitrate solution (see below).

Following the normal measurement process outlined in section 6, take five readings of a standard (100 ppm) nitrate solution with the first five test strips from a newly opened container, **with the meter's Lot number selected to LOT 5.**

Assume, for example, that the five test results were 91, 89, 96, 94 and 93 ppm; an average value of **92.6** ppm. From this average, derive a correction factor ('CF') being $100/92,6 = \mathbf{1.080}$



All future readings obtained with the CB1030 using this particular batch of test strips should then be **multiplied** by this CF (1.08). **See section 5.5 below.**

Similarly, for a subsequent, different batch of test strips, the five initial test readings might, for example, (and still using a standard 100 ppm solution) give results of 104, 109, 112, 101, 111 ppm; an average value of **107.4** ppm. From this average, derive a CF of $100/107.4 = \mathbf{0.931}$.

All future readings obtained with the CB1030 using this particular batch of test strips should then be multiplied by **0.93**. **See section 5.5 below.**

When using a standard solution in this way, do **not** dip the test strips into the main solution container. If dipping the test strips at all, first dispense a small amount of standard solution into a smaller container and then dip the test strips in this: better, use a micro-pipetter or syringe as described in section 5.3.

5.5 Lot number selection

To avoid the need manually to apply a correction factor to each new reading, the meter's Lot number selection can be altered to achieve the same effect automatically, to a close approximation, as follows (see section 6.2 for procedure):

Correction Factor (CF)	< 0.83	0.83–0.87	0.88–0.92	0.93–0.97	0.98–1.02	1.03–1.07	1.08–1.12	1.13–1.17	> 1.18
Set meter to Lot number	1	2	3	4	5	6	7	8	9

Once an appropriate Lot number is set, displayed/stored readings must of course be used directly and *not* further adjusted by CF.

Note: The Lot number remains as selected until manually changed (or 'lost' because of battery exhaustion or removal). When a particular batch of test strips has been exhausted, therefore, and before starting to use another batch, it is important that **either** the meter's Lot number is reselected to **Lot 5** (the 'mid-range' calibration of the meter), **or**, if required, the new batch is characterized as described above, and a new Lot number selected for use with that batch, based on its own Correction Factor (CF).

5.6 Dilutions

If it is known that a nitrate sample is likely to yield a concentration in excess of the meter's maximum level of 500 ppm (mg/l), or if a reading of an unknown sample has resulted in a HI display, dilution of the sample is necessary to provide a quantified reading.

Although any dilution ratio is possible, standardizing on one or two fixed ratios to minimize the possibility of error or confusion.



1:100 dilution: mix 99 ml of nitrate-free water with 1 ml of sample. Readings obtained with the resultant diluted mixture must then be multiplied by 100 to give the nitrate concentration in the original sample: e.g. a displayed reading of 63 = 6300 ppm nitrate.

1:10 dilution: mix 9 ml of nitrate-free water with 1 ml of sample. Readings obtained with the resultant diluted mixture must then be multiplied by 10 to give the nitrate concentration in the original sample: e.g. a displayed reading of 245 = 2450 ppm nitrate.

5.7 Standard solutions

Standard solutions should always be stored in a refrigerator (4°C or lower), in tightly closed containers to prevent evaporation or possible contamination, and should be used within a week of manufacture.

To make a standard nitrate solution, carefully weigh 1.63 grams of AR grade Potassium Nitrate into a 100 ml volumetric flask (or 16.3 grams into a 1000 ml flask). Make up to volume (100 ml or 1000 ml as applicable) with distilled (nitrate-free) water. Shake well: the resultant solution represents 10,000 ppm.

Extract 10 ml of the 10,000 ppm solution into a 100 ml volumetric flask, and make up to volume with distilled water (giving a 1,000 ppm solution), and finally repeat the process to generate a 100 ppm solution which can then be used to standardize test strip batches, if greater accuracy is required, as described in section 5.4.

6. **Taking a reading**

1. Open the hatch – the display briefly shows **8888**, then shows **CAL**
2. If a Lot number has already been accepted on a previous occasion, this will now flash to indicate that it can be changed if required – see sections 5.4 and 5.5.
 - If no Lot number has previously been selected, this will be indicated by a flashing – in the top right-hand corner of the display. A Lot number must be selected by use of the ▲▼ buttons, before further operation can continue.
 - If no Lot number has been previously selected, and the batch of test strips to be used have not been ‘characterised’ as described in section 5.4, select **Lot 5** – this will set the meter to its ‘median’ calibration.
 - If **Lot 5** is already displayed, and ‘median’ calibration is acceptable, proceed to stage 3 below.
 - If a different Lot number is already displayed, and this matches the Lot number to which the batch of test strips to be used has been ‘characterised’, proceed to stage 3, below.
 - Otherwise, select the correct Lot number, by means of the ▲▼ buttons, and then proceed to stage 3, below.



3. Remove a Mquant Nitrate test strip from its container (close the container immediately, and check expiry date).
4. Carefully and fully insert the unused test strip into the meter's read-head, between the hinged retaining tongue and the face of the carrier, with the test strip's pad downwards and facing towards the meter's body – see picture on the right.

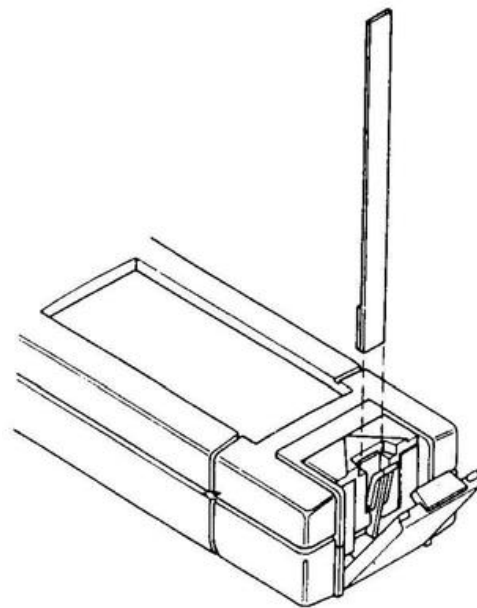

5. Close the hatch: the display will show ---, followed by **GO** and two beeps, indicating that the meter has accepted the unused test strip and 'zeroed' on it.

Err may be displayed instead of **GO** after this initial auto-calibration procedure, indicating that the test strip used for calibration seems unacceptable to the meter. Possibly the unused strip is too dark (perhaps because of unsuitable storage conditions, or because it is past its 'use-by' date), or has been incorrectly inserted.

Reopen the hatch, and the display will revert to **CAL**. Remove the test strip, and check for reasons. This procedure must be repeated until **GO** is obtained.

6. At **GO**, open the hatch and remove the test strip. Approximately five seconds after opening the hatch, the meter will beep at the start of a 60 second countdown period (shown on the display), immediately preceded by two short warning beeps at one second intervals.
7. Upon removal, the test strip must *immediately but carefully* be dipped in the solution to be analysed, for two seconds, and therefore removed from the solution before the start of the 60 second countdown.

Upon removal, hold the test strip in air for a further two seconds to allow absorption, and then shake it if necessary to remove any remaining excess solution. However, do *not* touch, wipe or dab the test strip: this will cause colour loss and avoidable measurement inaccuracy. Make sure the reagent pad is evenly coloured.

8. As the countdown approaches zero (after 60 seconds), the meter beeps a '3, 2, 1' warning. At the start of this warning, carefully re-insert the test strip (again, pad downwards and facing towards the meter's body), and close the hatch. With hatch closed, measurement takes place automatically at the end of the countdown (if the hatch is still open, shut is displayed). Do not delay inserting the test strip: consistent timing of the reaction is important for consistent measurement.
9. The symbol "---" will be displayed, followed by the measurement value in ppm (mg/l) of nitrate – eg. **47 ppm**.

If the display shows **HI**, the level of nitrate detected exceeds the meter's maximum range. This probably means that a dilution is required: see section 5.5.

If the display shows **LO**, the level of nitrate detected exceeds the meter's minimum range. Both sample and operating procedure should be checked, and the test repeated if appropriate. If the sample has been diluted, then probably a reduced dilution factor is required.



10. After noting the result, open the hatch and remove test strip. The display will show **8888**, followed by **CAL**, and the reading just taken will be stored in memory. If no more readings are to be taken, close the hatch again, and the meter will switch itself off. Alternatively, further readings can now be taken, or the memory reviewed as described in section 3.

If the meter is accidentally left switched on, it will automatically turn off after about two minutes. Memory storage is not lost.

7. CARE AND MAINTENANCE

7.1. GENERAL

The CB1030 should be handled with care. Although it is robustly made, it must be treated as a precision instrument, and not subjected to severe mechanical shocks which might cause malfunction. It is advisable to avoid subjecting the meter to extremes of heat, cold or humidity. In particular, water or steam should never be allowed to enter the meter, as permanent damage is likely.

The surface of the display can be cleaned by wiping it gently with a soft tissue from time to time, but care should be taken not to damage the glass surface, and only very light pressure should be used. The meter can be cleaned with a damp cloth – any solvent which might damage the surface should not be used.

The meter's read-head and test strip carrier must at all times be clean and free of any dirt or dust which might cause incorrect readings. How often cleaning is needed will depend on frequency of use: it is recommended that the carrier, in particular, should be cleaned once a week during periods of intermittent use, or daily during particularly heavy periods of use.

The test strip carrier can be removed from the read-head for cleaning by opening the hatch and then, with the forefinger, pushing the top of the hinged retained 'tongue' away from the carrier, in the same direction as the hatch opening. This will cause the test strip carrier to be lifted out of position, so that it can be removed by gripping it between thumb and forefinger and pulling it vertically upwards – see picture on the next page.

The carrier can be cleaned with a damp soft cloth, or washed in soap and water if necessary. The read-head surface should also be carefully cleaned with a small brush, dampened if necessary, ensuring that all deposits are removed from this area.

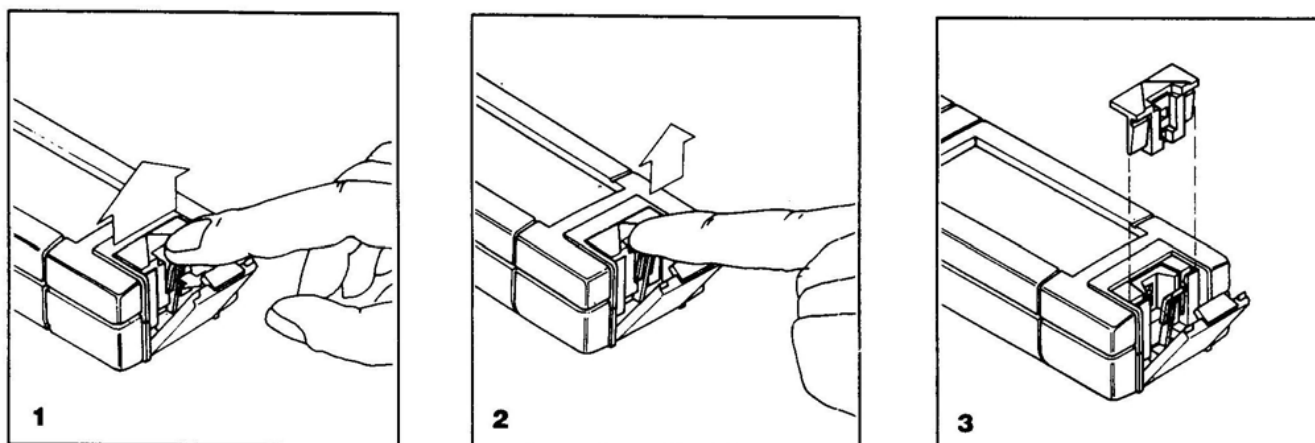

Very particular care must be taken if/when cleaning its small optical windows: never use a screwdriver or any other hard or sharp implement which might scratch or break these surfaces. Ensure that all surfaces are thoroughly dry before replacing the carrier.

To replace the carrier after cleaning, simply re-insert it vertically into the read-head, 'click' it into position, and close the hatch.

7.2 CHECKER

The meter is supplied with a small plastic checker to enable a simple test to be carried out from time to time to confirm the meter's calibration. The checker should be protected from excessive daylight, extremes of temperature, and from scratches and dirt. If it is damaged or becomes discoloured in any way, a replacement from your supplier is recommended.

To check the meter's performance, open the hatch and select Lot 5 if not already selected. Fully insert the checker, dark side facing away from the meter, in the same way that a test strip would normally be inserted. Close the hatch: the meter should accept the checker as if it were an unused test strip, and display **GO**. Open the hatch and remove the checker.

At the end of the timing period, when an exposed test strip would normally be read, insert the checker again, but this time with the dark side facing towards the meter. Close the hatch: the result obtained should be within the limits printed on the back of the meter (between 129-149).

If the reading is out of range, examine the checker for damage, and check that the test strip carrier and read-head are clean.

Try again, in case the checker has been inserted incorrectly. If incorrect readings are still obtained, consult your supplier.

Remember to re-set the meter's Lot number, if applicable, after a checker test.



TO MEASURE  TO KNOW

Nieuwkoop BV

Aalsmeerderweg 249 -S

1432 CM AALSMEER

0297 325836

info@nieuwkoopbv.nl

www.meten.nl



NIEUWKOOP